

# AC1100 User Guide

---

Version eng-1.10



**UNION**  
COMMUNITY

---

Copyright 2000 By Union Community Co., LTD.

## &lt;Revision History&gt;

Version	Date	Description	Firmware Version
1.00	2016-04-24	Initial Release	V1.00.000-010
1.01	2016-05-10	Update	
1.02/3	2016-05-31	Update Images	V1.00.000-013
1.09	2017-01-10	Face detection capture image update	

## < Glossary >

- Admin, Administrator

- A user who can enter into the terminal menu mode, he/she can register/modify/delete terminal users and change the operating environment by changing settings.
- If there is no administrator for a terminal, anyone can change the settings. In this regard, it is recommended to register at least one administrator.
- Caution is required with registration and operation because an administrator has the right to change critical environmental settings of the terminal.

- Authentication Method

- This represents the various types of authentication, including Mobile authentication, Password authentication, RF (card) authentication or a combination of these methods.

Example: Card or Password: Authentication with Card or Password

## Contents



<Revision History> .....	2
< Glossary> .....	3
<b>Contents</b> .....	<b>4</b>
<b>1. Before use</b> .....	<b>6</b>
1.1. Safety precautions .....	6
1.2. Specific names of the terminal .....	7
1.3. Normal Window Display .....	8
1.3.1. Icons .....	8
1.3.2. Window Messaging.....	10
1.4. Voices in the operation .....	17
1.5. Beep or sound effect in the operation .....	17
<b>2. Product introduction</b> .....	<b>18</b>
2.1. Product characteristics .....	18
2.2. Product components .....	19
2.2.1. Stand-alone (entrance) .....	19
2.2.2. Connected with PC server .....	20
2.3. Product specification .....	21
<b>3. Environment setting</b> .....	<b>22</b>
3.1. Checks before setting the environment .....	22
3.1.1. Entering the admin menu .....	22
3.1.2. Administrator authorization .....	23
3.1.3. How to enter the menu without administrator authorization .....	23
3.1.4. How to save the set values .....	24
3.2. Menu composition .....	25
3.3. User management .....	28
3.3.1. Adding User .....	29
3.3.1.1. Photo registration .....	30
3.3.1.5. Password registration .....	31
3.3.1.6. Card registration .....	32
3.3.1.8. Authorization method .....	33
3.3.1.9. Save .....	34
3.3.2. Deleting User .....	35
3.3.3. Modify User .....	37
3.3.4. Delete all Users .....	38
3.3.5. View.....	39
3.4. Network Settings .....	41
3.5. Application .....	43
3.5.1. Application mode .....	43
3.5.1.1. Modes .....	43
3.5.2. Function keys .....	45
3.6. System .....	47
3.6.1. System .....	47
3.6.2. Mobile .....	49
3.6.3. Face .....	51
3.6.5. .....	53
3.6.6. Database .....	54
3.6.1.1. Database Confirmation .....	55
3.7. Terminal settings .....	56

3.7.1. Sounds .....	56
3.7.2. Terminal .....	option
.....	57
3.7.3. Terminal Input .....	59
3.7.4. Terminal Lock .....	61
3.7.5. Terminal Wiegand .....	62
3.7.6. Terminal External .....	63
<b>3.8. Display settings .....</b>	<b>65</b>
3.8.1. Theme .....	65
3.8.2. Camera .....	66
3.8.2.1. Camera Flash Option .....	66
3.8.3. Language .....	67
3.8.4. LCD option .....	67
3.8.5. Message time settings .....	68
<b>3.9. Terminal information .....</b>	<b>70</b>
3.9.1. System information .....	70
3.9.2. Terminal information .....	71
3.9.3. Network information .....	72
3.9.4. User information .....	73
3.9.5. Log information .....	74
3.9.6. About .....	75
<b>3.10. SD USB .....</b>	<b>76</b>
<b>3.20. Language Translations/Customizing Text Items .....</b>	<b>82</b>
<b>4. How to use terminal .....</b>	<b>84</b>
<b>4.1. Authorization mode change .....</b>	<b>84</b>
<b>4.2. ID input .....</b>	<b>85</b>
<b>4.3. Authorization .....</b>	<b>86</b>
4.3.3. Card authorization .....	86
4.3.4. Password authorization .....	86

# 1. Before use



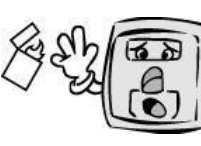

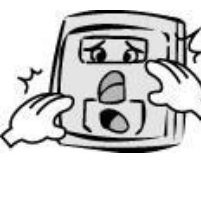
## 1.1. Safety precautions

### ● Warning

<p>Handling with wet hands or allowing liquid to flow into it is prohibited. -&gt; It may cause an electric shock or damage.</p> 	<p>Do not place a fire source near the terminal. -&gt; It may cause a fire.</p> 
<p>Do not disassemble, repair, or modify the terminal at discretion. -&gt; It may cause an electric shock, fire or damage.</p> 	<p>Keep out of reach of children. -&gt; It may cause an accident or damage.</p> 

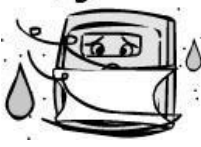
- If the above warning is ignored, it may result in death or serious injury.

### ● Cautions

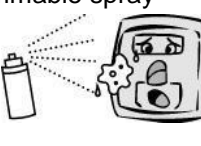
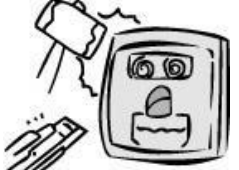
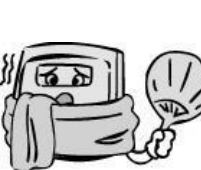
<p>Keep away from direct sunlight -&gt; It may cause deformation or color change.</p> 	<p>Avoid high humidity or dust -&gt; The terminal may be damaged.</p> 
<p>Avoid using water, benzene, thinner, or alcohol for cleaning -&gt; It may cause an electric shock or fire.</p> 	<p>Do not place a magnet close to the terminal. -&gt; The terminal may break down or malfunction.</p> 
<p>Do not contaminate the fingerprint input area. -&gt; Fingerprints may not be well recognized.</p> 	<p>Avoid using insecticide or flammable spray near the terminal. -&gt; It may result in deformation or color change.</p> 
<p>Avoid impacts or using sharp objects on the terminal. -&gt; The terminal may be damaged and broken.</p> 	<p>Avoid severe temperature changes -&gt; The terminal may be broken.</p> 

- If the above cautions are ignored, it may result in property loss or human injury.

※Under no circumstances will UNION COMMUNITY be responsible for accidents or damages caused by inappropriate use of the product without referring to the user manual.





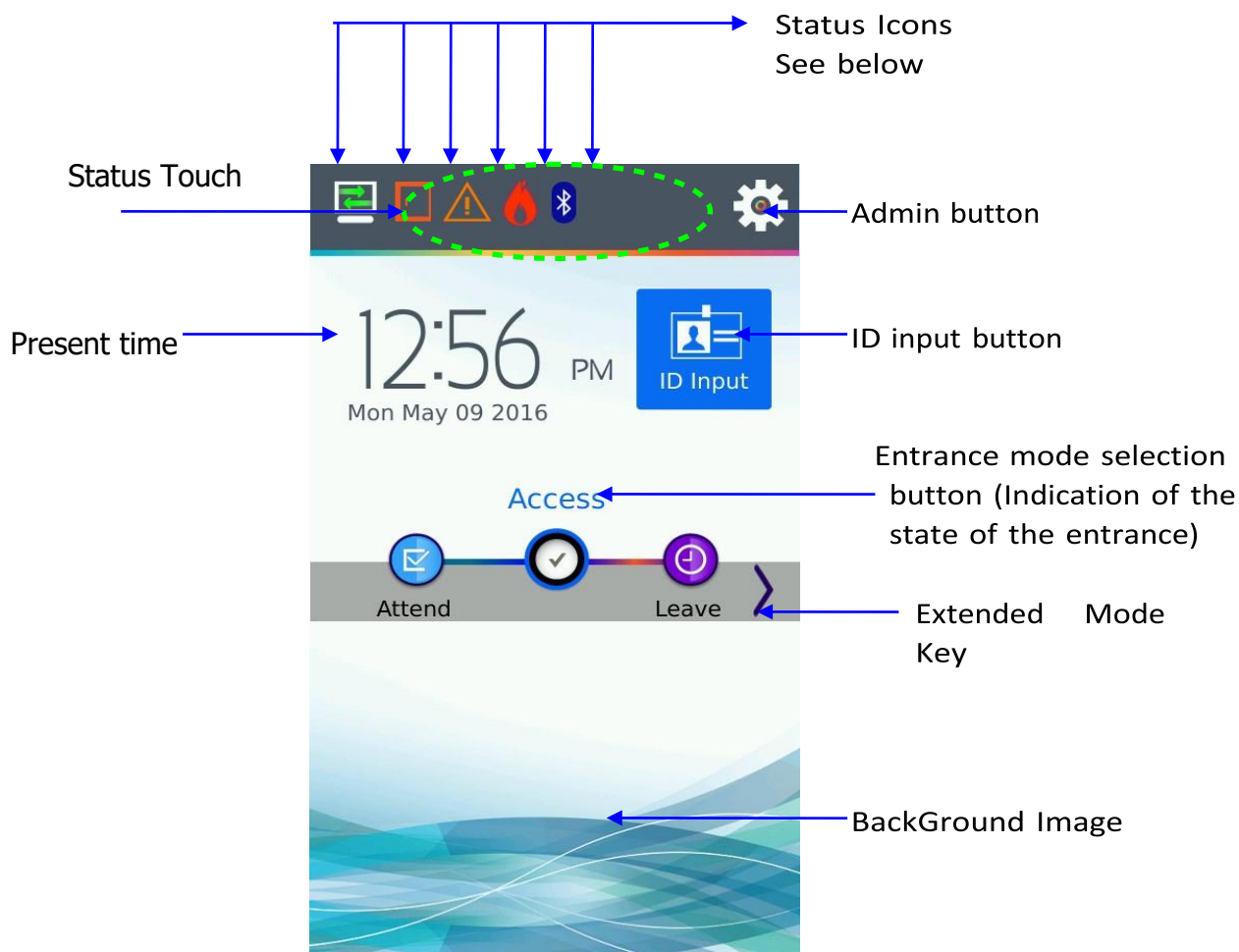

## 1.2. Specific names of the terminal



### 1.3. Normal Window Display



#### 1.3.1. Icons

Fire detection	None	: Normal
		: Fire Detected state (external device or server program)
Warning indicator	None	: Normal
		: Abnormal terminal state (tampered)
Door state		: Door state unknown
		: The Door is closed
		: The Door is opened
Server connection state		: LAN line is not connected
		: Not connected to the server program
Bluetooth		: Connected to the server program
		: Bluetooth Mobile App Connected State



WiFi Connection  
State



: WiFi Dongle Connected to device – not connected to network



: WiFi Dongle Connected and successfully connected to AP

### 1.3.2. Window Messaing

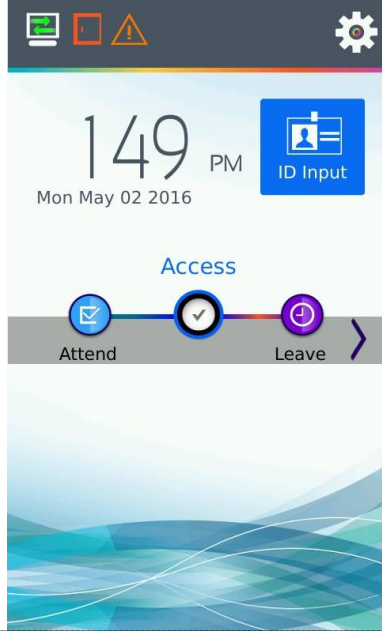

- Standard window

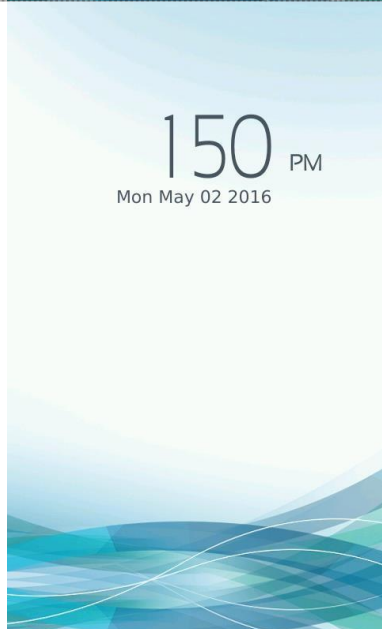

- Screen Saver window

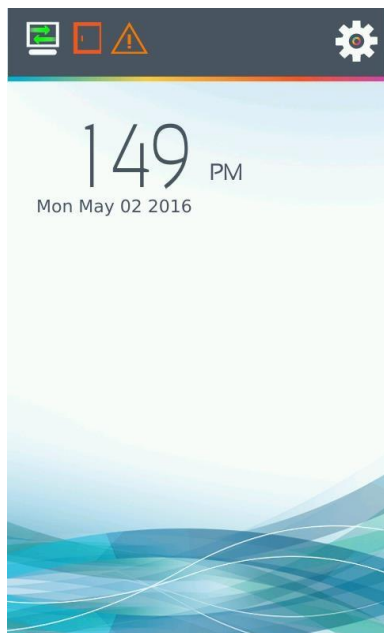

All Function Keys disabled  
- No Status Text/ Status Text Background  
- No Extended Key

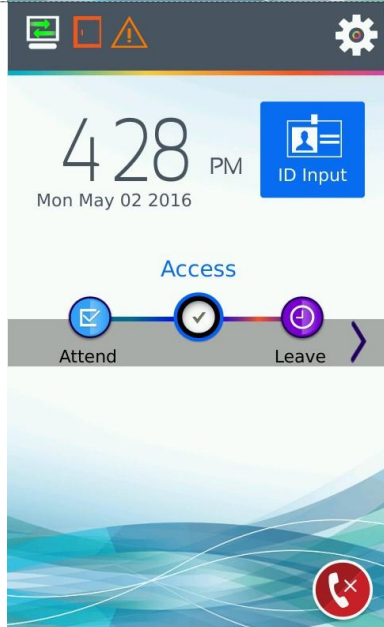

VoiP Function



VoIP enabled, not registered.



VoIP enabled, registered on iPBX network  
Select Green Icon to access VoIP call menu.

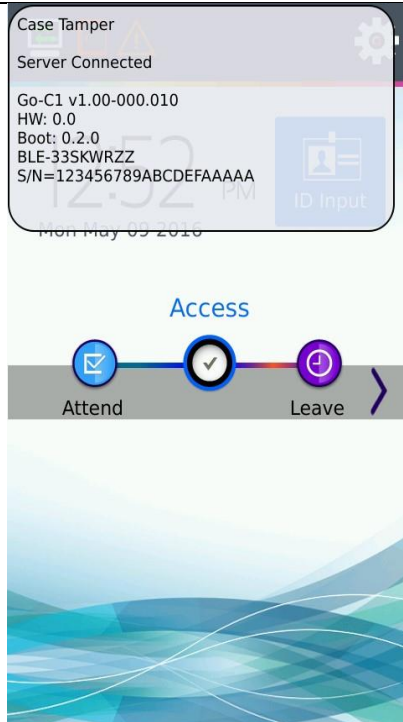

Touch the “status touch area” along the top of the display to see detail status information. See 1.3 Main window display. This will appear for 10 seconds.

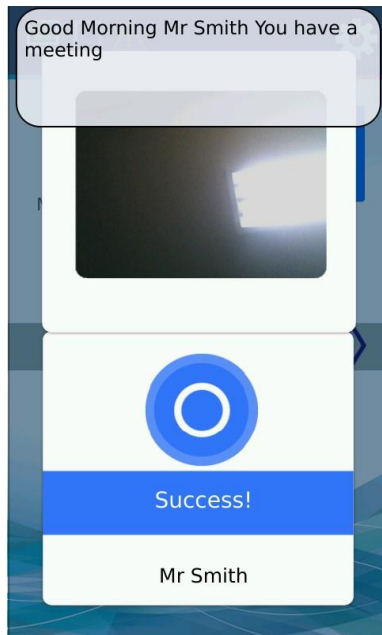







Top pop up is a “custom user message”. In UNIS user management you can make a custom message for every user during the users authentication period.



If camera setting for Display Current Picture or Display User picture is set and registered card is used. Picture will be displayed on the top. See Section 3.8.2

If card, mobile key, password is successful, the general Success message will be displayed.

Bottom Message is black can be 1 of 3 different options. This depends on the setting in Display “User Display Options”

- User Name
- User ID
- User Key

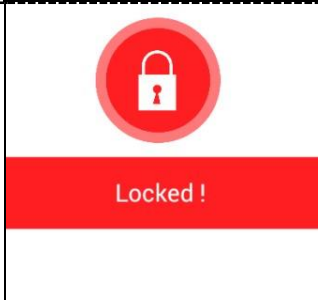
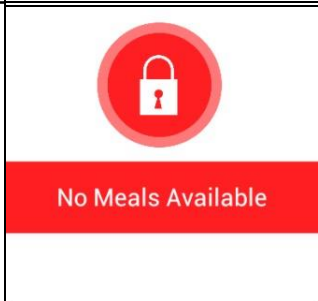
 <p>Failed!</p>	<p>- When authorization is failed.</p>
 <p>Unregistered!</p>	<p>- When unregistered user ID is entered.</p>
 <p>Unregistered Card!</p>	<p>- When unregistered card is entered</p>
 <p>Passback error!</p>	<p>- Passback error when using anti-passback function.</p>
 <p>Duplicated!</p>	<p>- When a user tried the authorization more than twice in one meal time when using as meal personnel management</p>
 <p>Network Error!</p>	<ul style="list-style-type: none"> <li>- When the server does not respond during the authorization attempt to the server</li> <li>- When the network is disconnected during the authorization attempt to the server</li> </ul>

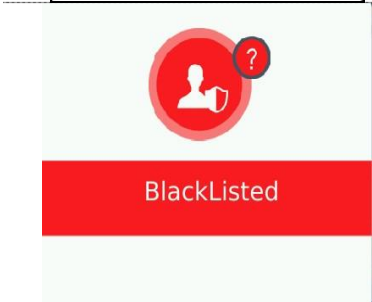
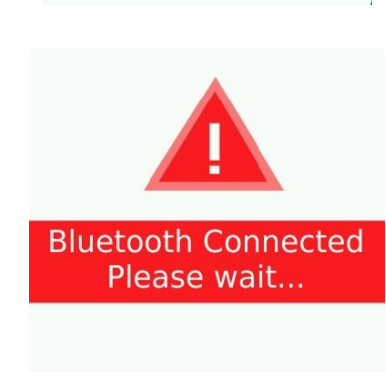
	<p>- When the terminal is set locked</p>
	<p>- When it is not the meal time when set in the meal personnel management.</p>
	<p>- Registration without authorization right or authorization attempt when the entrance is not permitted.</p>
	<p>- When the user is designated in the blacklist</p>
	<p>- When Bluetooth is connected with administrator Mobile App. Admin mode blocking.</p>

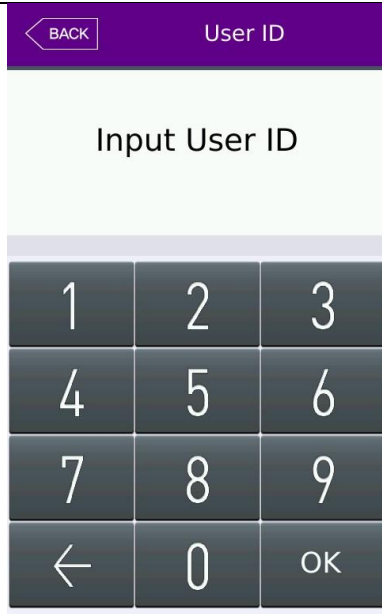

- Waiting for User ID Input

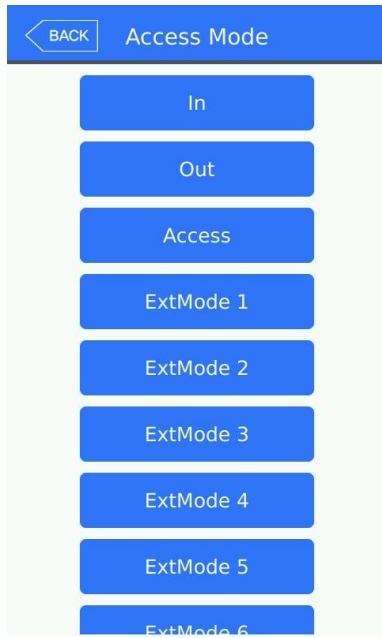

If more than 2 function keys are enabled from the function key setting menu, in administrator mode, the  button will appear on the main window. If this button is selected the extended function keys can be seen. Select the mode button - blue, or scroll down/up until you can see the mode you would like to select. Select back or the blue button mode. Timeout after 5 seconds of no activity.

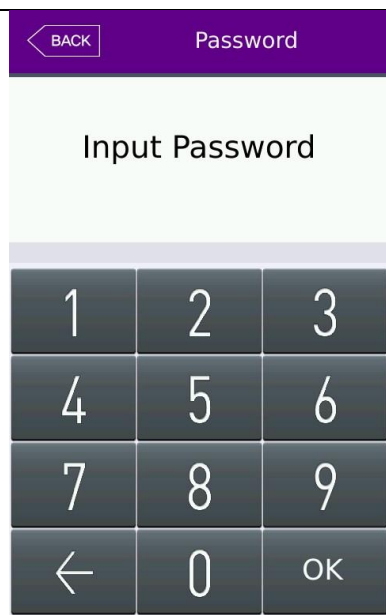

- Waiting for Password Input

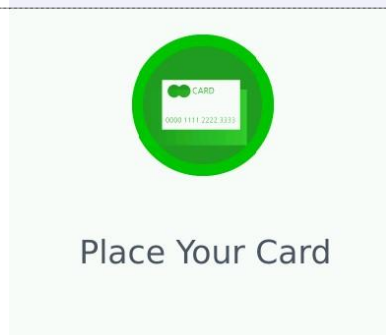

- Waiting for Card



-When the terminal program is being upgraded  
(In this state, you should not turn off the terminal)



#### 1.4. Voices in the operation

Operation type	Voice
When the authorization was successful	You are authorized.
When the authorization was failed.	Please try again.
Waiting for Card	Please enter your card
ID Input	Enter your ID

#### 1.5. Beep or sound effect in the operation

Beep	Card Reading	When the card was read
ErrorTone wave sound	When failed	When the authorization has failed and Voice disabled
Trilling sound	When success	When the authorization was successful and Voice disabled
	Key Press	Sound during number entry
Tick	Function Key	Sound during function key selection

## 2. Product introduction

### 2.1. Product characteristics

- Multi-Modal product with card, password or mobile key authentication methods. ● Face Detection requires the current authenticating user to present their face during card, password or Mobile Key authentication. This requires a user to be in front of the card reader so the device can take a picture of the person who authenticated.
- Built in camera flash allows pictures and face detection during dark conditions.
- Daylight Sensor automatically turns the flash on during dark conditions.
- RF (125 kHz) Type (optional)
- Smart card (13.56MHz) Type (optional)
  
- Entrance management system using TCP/IP or WiFi (optional) connected to a server database.

● **Various registration and authorization methods**

Card		Card registration Card authorization
Password		Password registration Password authorization
Mobile Key		Mobile Key Temporary key registration Mobile Key User key registration
Card password	or	Card, password registration Card or password authorization
Card password	and	Card, password registration Password authorization after card authorization
(ID or card) & password		Card, password registration Password authorization after ID input or password authorization after card.



---

## 2.2. Product components

### 2.2.1. Stand-alone (entrance)

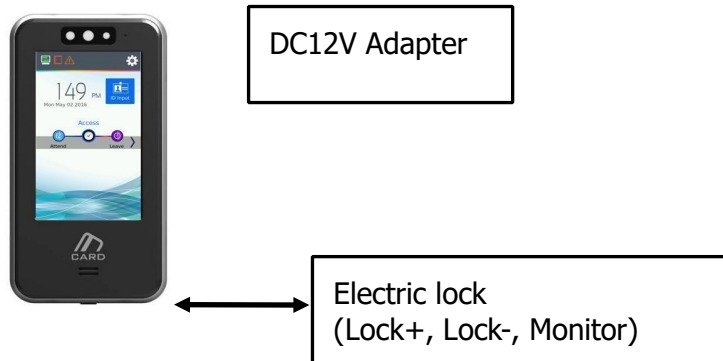

2.2.2. Connected with PC server

(Entrance, attendance, meal personnel management)

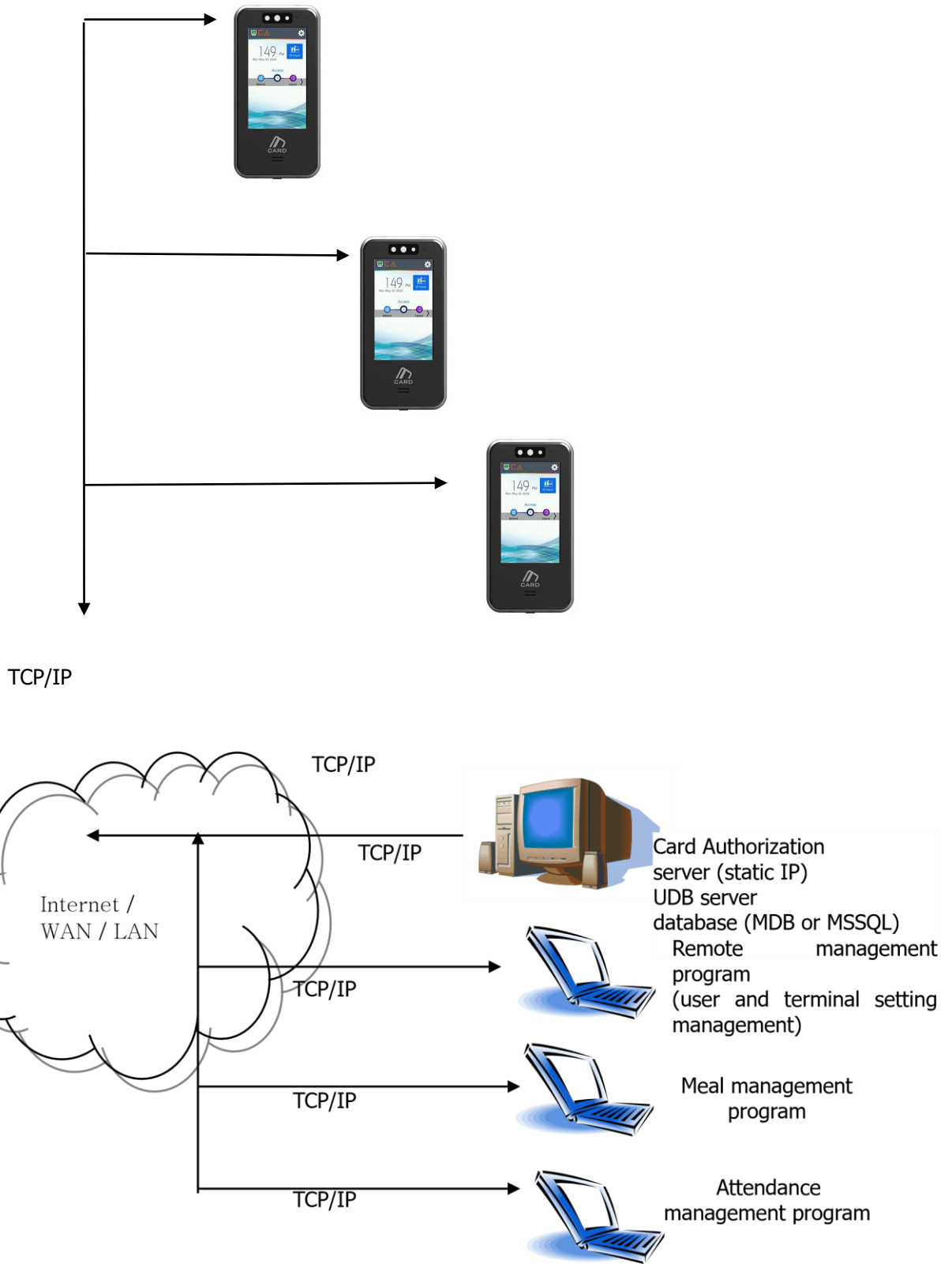

## 2.3. Product specification

Types	SPEC	REMARK
CPU	1GHz Single Core CPU	
LCD	4.0 inch Touch LCD(480*800)	
MEMORY	eMMC 8G Bytes Flash	
	512mb RAM	
External USB support	Data backup / FW upgrade	
Camera	Still Image Color (320x480)	
Camera Flash Sensor	Daylight sensor will turn on flash when needed	
User number	200,000 User / 200,000 Card / 35000 Image 1,000,000 Log / 35000 Image Log	
Temperature / Humidity	-20 ~ 60 / Lower than 90% RH	
AC / DC Adapter	INPUT : Universal AC100 ~ 250V	
	OUTPUT : DC 12V (Option : DC 24V)	
	UL, CSA, CE Approved	
Lock Control	EM, Strike, Motor Lock, Auto Door	
I/O	4 In (1 Exit, 3 Monitor) 2 Output (Lock 1 , Lock2)	
Communication Port	TCP/IP (10/100Mbps)	Authorization server communication
	RS-232	Meal ticket printer
	RS-485	Controller communication
	Wiegand In/Out	Card reader or Controller communication
Card Reader	125KHz RF / 13.56MHz Smart HID 125K Prox card (option)	option

---

SIZE	66.6 X 139.6 X 9.5	With Bracket
------	--------------------	--------------

### 3. Environment setting

#### 3.1. Checks before setting the environment

##### 3.1.1. Entering the admin menu

If you press the  icon at the main window, you can enter the administrator menu as follows.

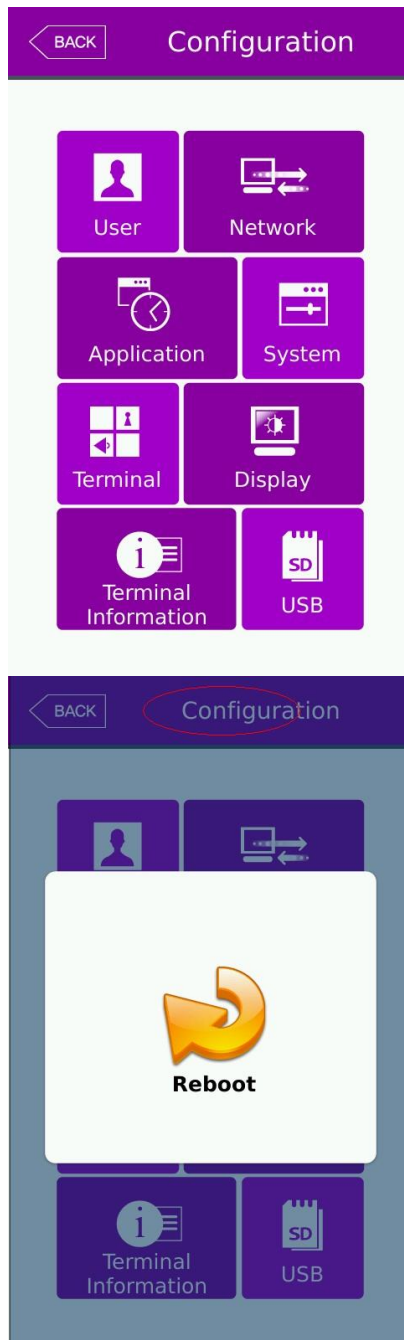

You can enter the subdivision menu by selecting each button.

Once in the administrator menu, if you need to soft reboot the device, touch the RED circled area, and then select the reboot icon in the middle, this will initiate a reboot.

### 3.1.2. Administrator authorization

If the administrator is registered, the following administrator authorization window appears first.



►Administrator authorization

If you enter the administrator ID, the administrator authorization is fulfilled along with the authorization method of the administrator such as card, or password.

The administrator authorization only appears when the registered administrator exists. The authorization is fulfilled only once when entering the menu mode and you can access to the entire menu until you quit the main menu.

3.1.3. How to enter the menu without administrator authorization

In cases where the administrator is lost you can enter a special ID and password to view the network settings of the card reader. This will allow you to connect using UNIS to reset or add a new administrator.

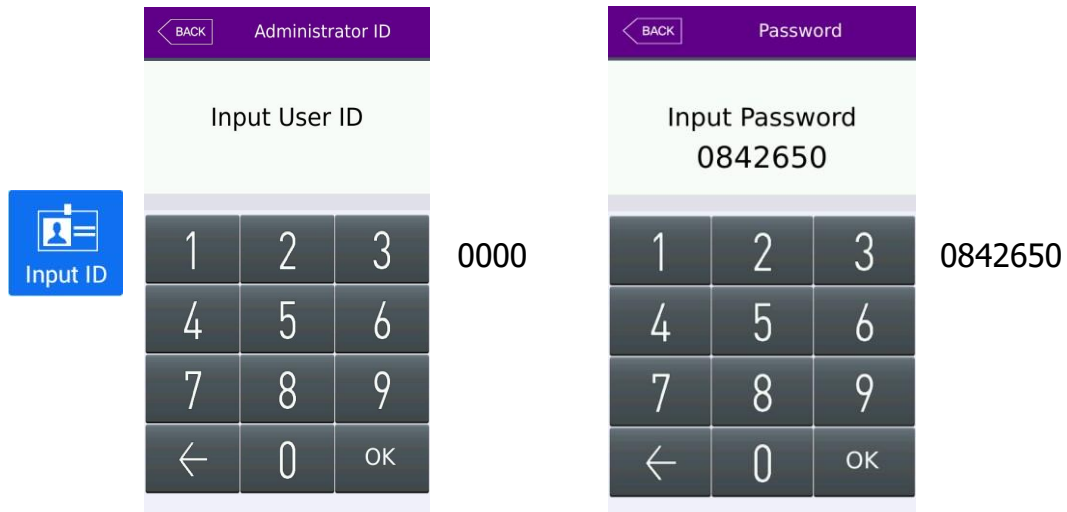



The server IP and network information will be displayed. You can now connect your card reader terminal directly to your PC. Setup your PC network card with the same Server IP and Gateway settings.

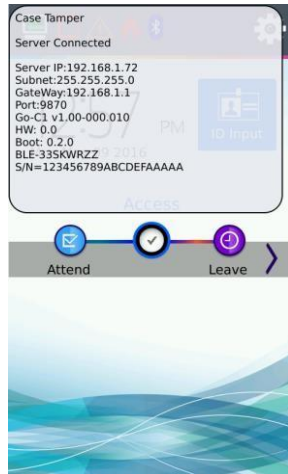

After you successfully connect with UNIS you can change/delete the administrator user as needed.

Method #2

Entering admin mode when you have lost the administrator ID

- 1) On USB device, create folder /CR/
- 2) On your PC create an empty file with no extension and name it 'factory'
- 3) Copy 'factory' file from PC to USB /CR/ folder
- 4) Plug USB into the card reader
- 5) Card Reader tamper must be Open (Cover open and off)
- 6) Successful user must authenticate and open the door, during the door open period, press the admin icon and it will bypass admin entry requirements.

3.1.5. How to save the set values

In each menu of the administrator mode, press the OK button to save changes. To cancel and not save, press the [BACK] icon at the top left.

If there is no touch or key press the menu will timeout after 60 seconds of no activity.

3.2. Menu composition

1.User management	1. Add 2. Modify 3. Delete 4. Delete All 5. View	
2. Network	Terminal IP address	Static IP / DHCP ▶Terminal IP address ▶Subnet mask ▶Gateway

	DNS server	
	Server IP address	▶Server IP address ▶Port
	Terminal ID	▶Terminal ID
	Timeout	▶Server timeout
3.Application	1. Application	▶Access ▶Attendance management ▶Meal management 1. ▶Schedule setting Attend (F1) time Leaving (F2) time Going out(F3) time Returning(F4) time Normal Access time Blocking Time 2. When setting as the meal management ▶Schedule setting Breakfast time Lunch time Dinner time Supper time Snack time ▶Duplicate meals
	2.Function Key	▶F1 use ▶F2 use ▶F3 use ▶F4 use ▶ID button ▶Access button ▶Extension Key use ▶ Number of extension keys

4. System	1. System	<ul style="list-style-type: none"> <li>▶User ID Length (2-9)</li> <li>▶Authentication Type (Server/Terminal) (Terminal/Server) (Server Only) (Terminal Only)</li> <li>▶Job Code enable/disable</li> </ul>
	2.Mobile	<ul style="list-style-type: none"> <li>▶Enable Mobile Key</li> <li>▶Mobile Key Name</li> <li>▶Mobile Register Device</li> </ul>
	3. Face Detection	<ul style="list-style-type: none"> <li>▶Card use</li> <li>▶Mobile use</li> <li>▶Password use</li>   <li>▶Detection Level Level 1 Level 2</li> </ul>
	4. Date / time	<ul style="list-style-type: none"> <li>▶Time Sync type</li> <li>▶Display format</li> <li>▶Date Setting</li> <li>▶Time Setting</li> </ul>
	6. Database	<ul style="list-style-type: none"> <li>▶ Delete all Users</li> <li>▶ Clear Settings</li> <li>▶ Clear Log Data</li> <li>▶ Clear Picture Logs</li> <li>▶ Factory Initialize</li> </ul>
	5.Terminal setting	1. Sound
2. Terminal option		<ul style="list-style-type: none"> <li>▶Card Reading display</li> <li>▶Card format</li> <li>▶Door Open Too Long Time</li> <li>▶Case Tamper enable</li> <li>▶Terminal Locked</li> <li>▶VoIP enable</li> </ul>

	3. Input setting	<ul style="list-style-type: none"> <li>▶M0</li> <li>▶M1</li> <li>▶M2</li> <li>▶IO</li> </ul>
	4. Lock setting	<ul style="list-style-type: none"> <li>▶Lock1 options</li> <li>▶Lock2 options</li> <li>▶Lock1 time (ms)</li> <li>▶Lock2 time (ms)</li> </ul>
	5. Wiegand	<ul style="list-style-type: none"> <li>▶Wiegand</li> <li>Site code</li> <li>Wiegand Output</li> <li>Wiegand Output Type</li> <li>Wiegand Input</li> </ul>
	6. External	<ul style="list-style-type: none"> <li>▶Printer option</li> <li>▶RS485 option</li> </ul>
6.Display	1. Theme	<ul style="list-style-type: none"> <li>▶Main background screen</li> <li>Background cycle period (seconds)</li> </ul>
	2. Camera	<ul style="list-style-type: none"> <li>▶Display option</li> <li>▶Save option <ul style="list-style-type: none"> <li>Save when authorization was successful</li> <li>Save when authorization was failed</li> </ul> </li> <li>▶Flash option <ul style="list-style-type: none"> <li>Disabled/Low/Medium/High Delay (milliseconds)</li> </ul> </li> </ul>
	3. Language	<ul style="list-style-type: none"> <li>▶Language</li> </ul>
	4. LCD option	<ul style="list-style-type: none"> <li>▶Screen saver setting</li> <li>▶User display option</li> <li>▶Touchscreen recalibrate</li> </ul>
	5. Message Setting	<ul style="list-style-type: none"> <li>▶Broadcast message display period <ul style="list-style-type: none"> <li>On Time (milliseconds)</li> <li>Off Time (milliseconds)</li> </ul> </li> <li>▶Display Result Window Period <ul style="list-style-type: none"> <li>Display time (milliseconds)</li> </ul> </li> </ul>

7. Terminal information	1. System	▶System information ▶System Storage ▶Ram
	2. Terminal	▶Terminal Information
	3. Network	▶Network information
	4. User	▶User information
	5. Log	▶Log information View Log
	6. About	▶About Legal
8. SD card	1. Export	▶User data ▶Event log ▶System option ▶Export All ▶Picture data
	2. Import	▶User data ▶System option
	3. Other	▶Theme Background import Language file import ▶F/W upgrade

### 3.3. User management

When you select the **[User Settings]** at the main menu, the following window appears.

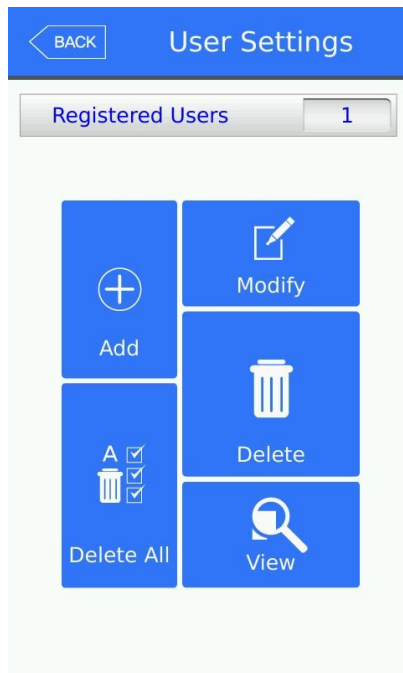

The number of all the users is shown at the top of screen including administrators.

Select [Add] button to add the new user, [Modify] button to modify the user, [Delete] button to delete the specific user, [Delete All] button to delete all the users, and [View] button to inquire the registered user list.

### 3.3.1. Adding User

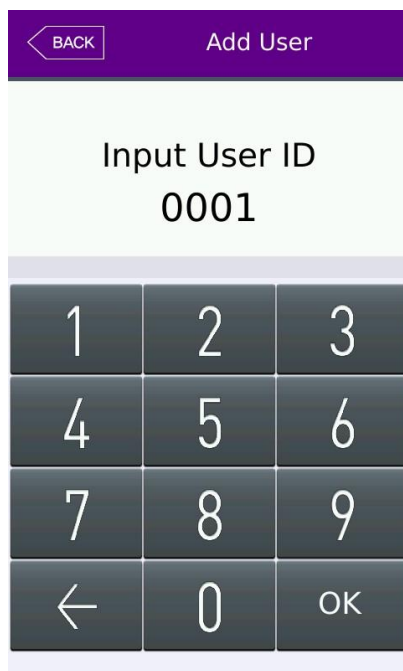

If you select [User Settings]->[Add] in the main menu, the following screen appears

Input the user ID to be registered and select [OK] button.

In this case, the ID which can be registered is shown on the screen automatically, so you can register conveniently. If you want to change ID, delete the

previous value by selecting the  button and input the new value.

Click [Back] button to cancel and go back.

If you enter ID which is already registered, a failure message appears, and if the ID is not already registered, the following screen appears.



ID:0001

Admin User

Admin User



The icons in the left side mean as follows.

:Password Registration (X: none, O: Registered) : Card Registration (X: none, 1~5)

: User ID to be registered

User Type: This selection will NOT appear until a card or password is registered for the user.

: User (normal)

: User (administrator)

button: Registration of picture

You can register a card with [Card] button, a password with the [Password] button, and change the authentication type. The default user will be a standard user and not an administrator.

※Users who are only registered as an administrator can change the settings of the terminal and can register/modify/delete the information of all the saved users. Take caution when registering an administrator.

### 3.3.1.1. Photo registration

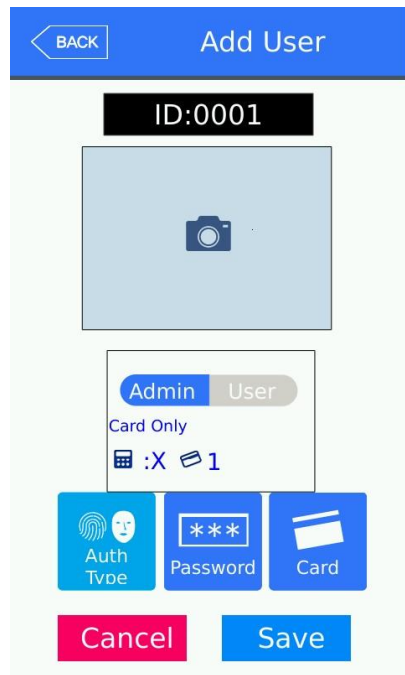

Take a picture by selecting [📷] button at the [Add user] screen. Keep selecting the picture image until you are satisfied with the current picture that has been taken.

### 3.3.1.5. Password registration



Enter a password up to 8 digits in length. Once you are finished select the OK button, after a confirmation window will appear.

appear.

!!! Enter the same digits to confirm your password is correct. Select the OK button to continue.

If password is has not matched an error message will

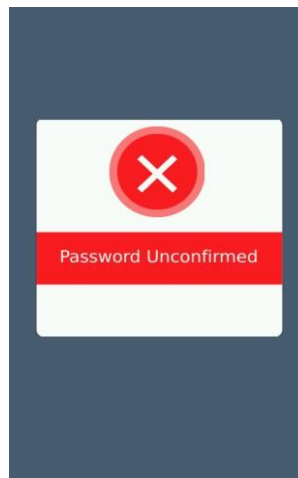

## 3.3.1.6. Card registration

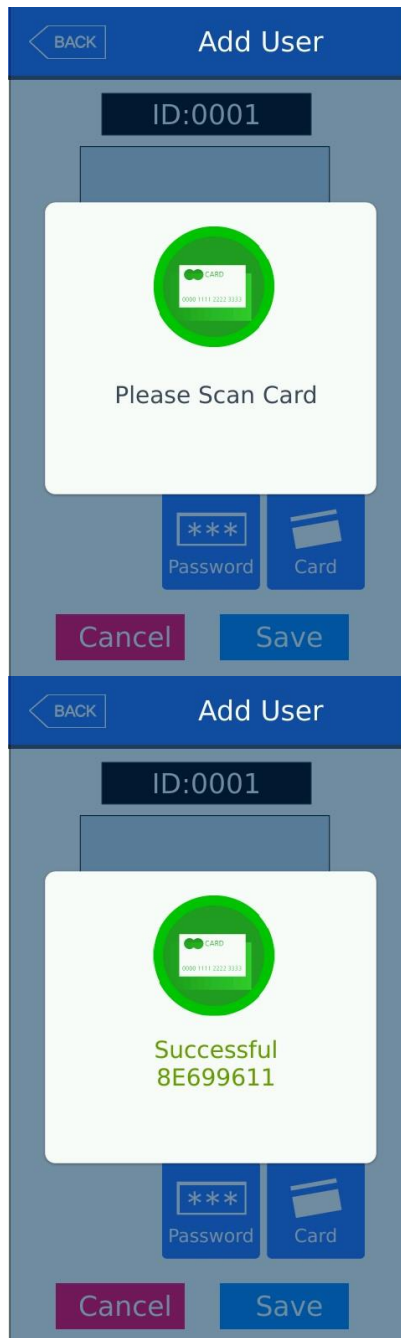

Select the Card Icon to register a card. A popup message will appear waiting for you to scan your card.

If successful the card number message will appear indicating successful.  
You can register up to 5 cards per user. If a same card number is attempted to register again, an error message will occur.

### 3.3.1.8. Authorization method

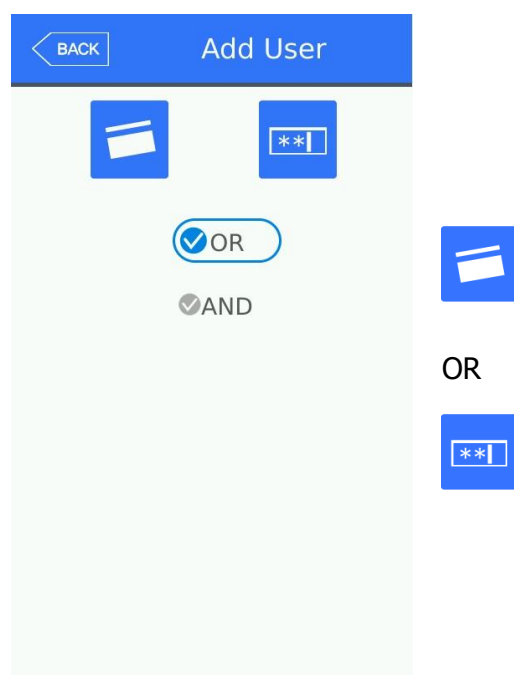

Select the Auth Type icon to change the authentication type of the user. If only card is registered, only a card icon will appear the same as password. If both are registered you can select a combination of both types using OR and AND.

: card

: password

saved.

By selecting the BACK button the current selection is

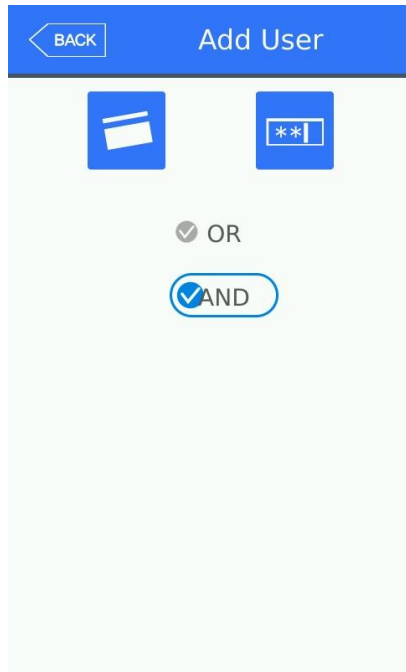



: card

AND

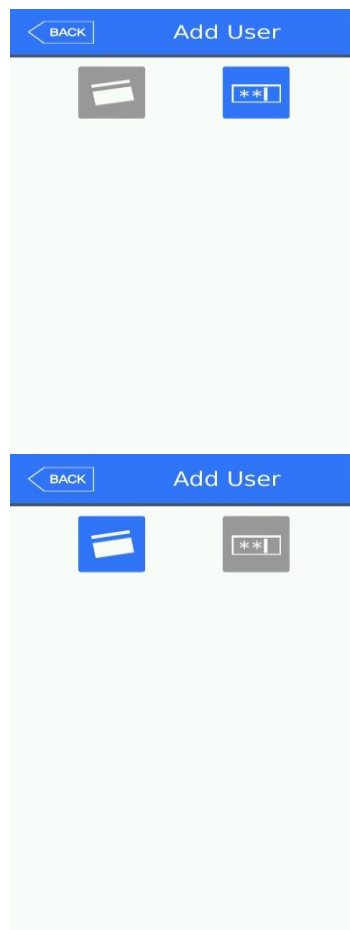

: password



 : password only

 : card only

### 3.3.1.9. Save

Select the [Save] button to save all user data when completed or select [Cancel] or [BACK] button to return, the user is not saved.

LCD messages which can appear during the registration procedure.

	<p>If user is not saved correctly this message will appear.</p>
---	---

### 3.3.2. Deleting User

The following window appears if you select [User Settings]->[Delete] at the main menu.



Input the user ID to be deleted and select [OK] button. Select [BACK] button to cancel and return.

If you entered an invalid/unregistered ID, an error message will appear.

If you entered a valid/registered ID a confirmation window will appear.

Please note if connected to the server, the user is not deleted from the server. You should synchronize and make sure the user is deleted in the server and the terminal. Once the user is deleted it cannot be recovered.

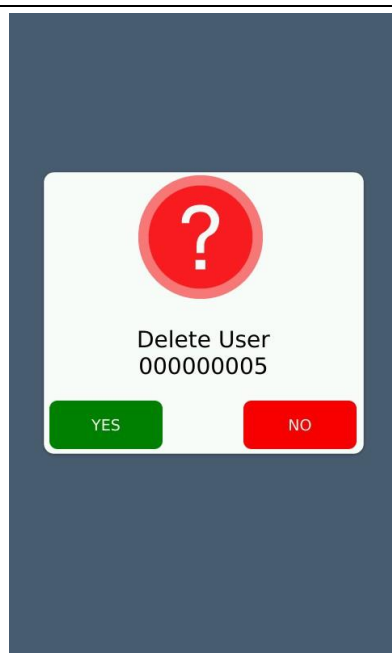

Confirmation Window.  
Select YES to continue to delete.  
Select NO to cancel the deletion.

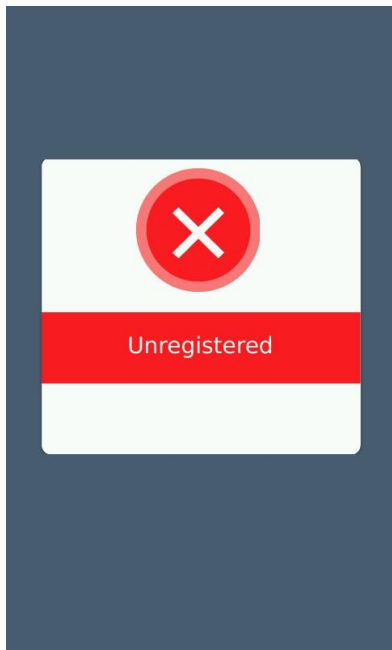

When unregistered ID was entered

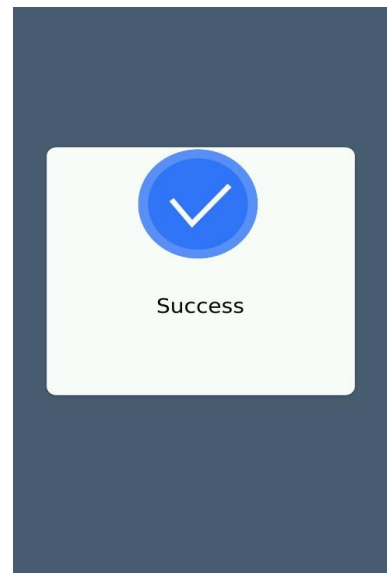

When user is deleted successfully.

### 3.3.3. Modify User

The following window appears if you select the [User Setting] -> [Modify] in the main menu.



Input the user ID to be modified and Select [OK] button. Select [BACK] button to cancel and return.

If you entered an invalid/unregistered ID, an error message will appear.

If you entered a valid/registered ID, the same menu as 'add user' will appear. Follow the same steps in the 'add user' section to change any current user settings

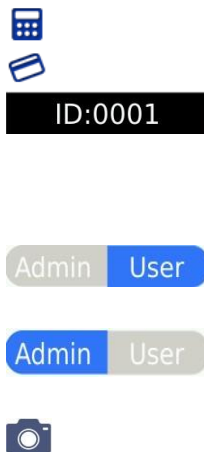
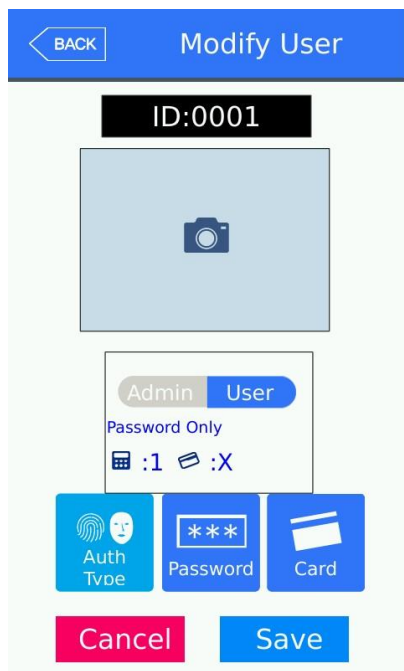

The icons in the left side mean as follows.

- :Password Registration (X: none, O: Registered) :
- Card Registration (X: none,1~5)



---

: User ID to be registered

User Type: This selection will NOT appear until a card or password is registered for the user.

: User (normal)

: User (administrator)

button: Registration of picture

### 3.3.4. Delete all Users

If you select the [User Settings] ->[Delete all] in the main menu, the following window appears.

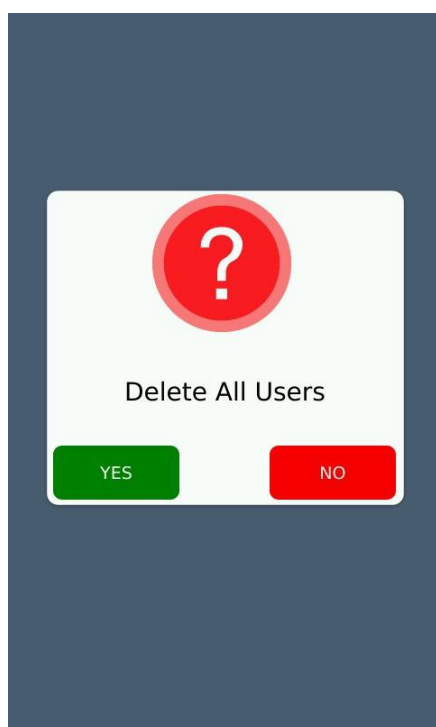

Confirmation Window.

Select YES to continue to delete all users Select NO to cancel the deletion.

### 3.3.5. View

If you select the [User management] -> [View] from the main menu, all the registered users can be viewed. User view area will show you a summary list of the users. User name, ID, Card number and authentication type will appear for each user. You can select a user for modification or deletion.

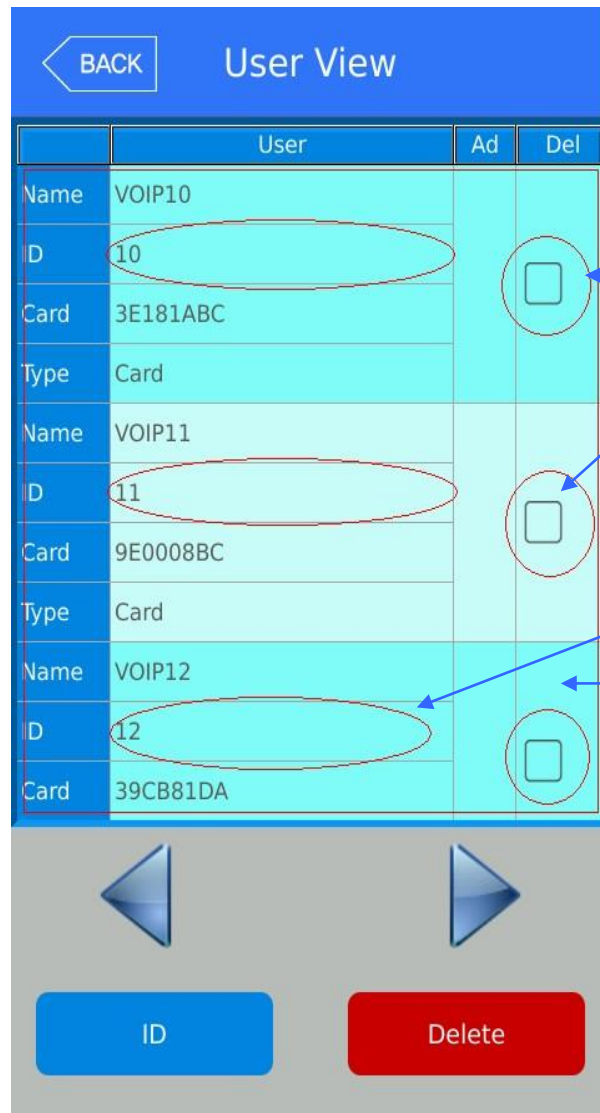

Select this area to toggle the User's Delete status

Select this area to select the user for modification

Slide up or down in the RED box area to view more or less users

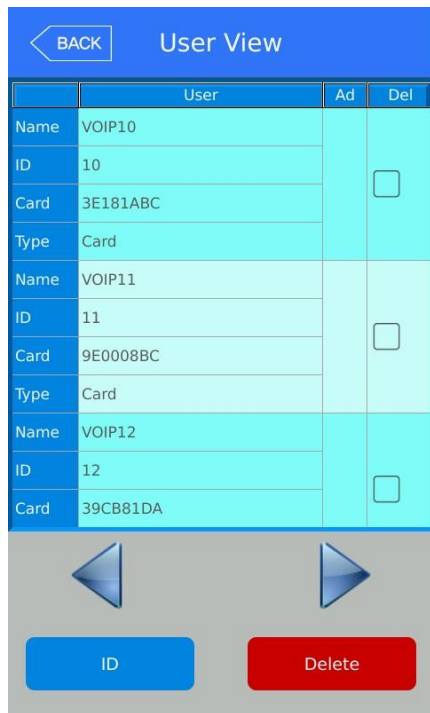

The maximum amount of users displayed is 50. You can slide up or down in the box area (see above) to move up and down the list. If more than

50 users (maximum display)  a forward icon will appear. If you select this, the next 50 users

will display. Select  to move to the previous 50 users.

▶ [ID]: Select the user ID area to move directly to the specific user’s modification window. See above picture

▶ [Del]: If you select this area, a checkbox will appear. Select the ‘Delete’ button to delete the selected users. If you wish to delete all users see section ‘Delete All Users’

▶ [Delete Button]: Once you select all the users

you wish to delete, select the ‘Delete’ button

to delete the selected users

If you select [BACK] button on the top, you can move to the previous ‘3.3 User management’ menu.

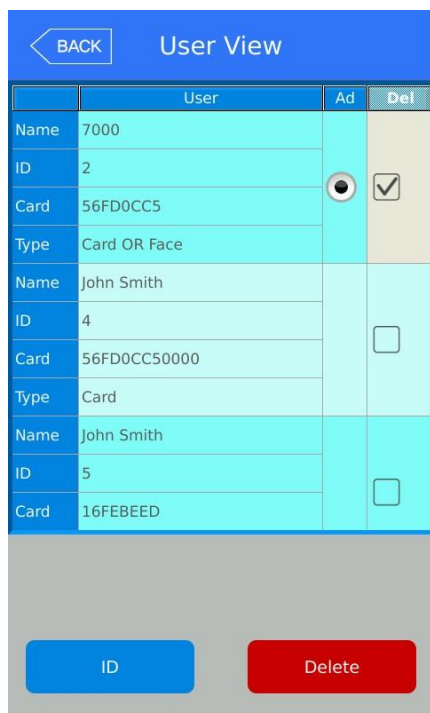

▶If you input the User ID by clicking [ID search] button, the user is searched like in the left picture. If you select the [BACK] button in this window, you can move to the ‘3.3. User management’ menu.

▶ [ID Button Search]: Select this and an ID input number window will appear. Enter the ID of the user you wish to view. After you select the ID, only the user id you selected will appear in the view area.

### 3.4. Network Settings

The networks settings area allows you to setup IP addresses, gateways, subnet mask, DHCP or static settings, Terminal ID Number or wireless settings. When selecting DHCP ensure that your network has a properly enabled DHCP server available. Also you should give time for the terminal to acquire the DHCP address; usually this can take from 1-60 seconds. While in this menu if you press the DONE button the server will be disconnected and the link will be reconnected to the server. You can re-initiate the network connection by entering this menu and pressing done.

Ethernet Setup Procedure:

- 1) Setup Static OR DHCP
- 2) If Static then set the terminal IP/Subnet Mask and Default Gateway.
- 3) Set the Server IP Address, PORT and Terminal ID
- 4) If using Wireless go to Wireless Options and Press "Available Networks" until your router appears in the available network window.
- 5) Press/Select the station you wish to connect to, it should be highlighted.
- 6) Go to wireless advance settings to set the Security Level/Rate or Channel.
- 7) Press OK.

Pressing OK will disconnect the current connection and then try to re-establish a new link from the setup parameters that were just entered. At anytime select the Back button to cancel and not save any changes.

►Basic setting: Same with the window at the left side.

Select the method [Static IP] if the static IP is allocated from the connected network, and select [DHCP] if the IP is allocated from the DHCP server in the connected network.

If you selected [Static IP], set the IP address, subnet mask, and gateway. And if you selected [DHCP], you will not have to set the IP, Gateway or Subnet.

- [Port]: The port value of the authorization server (server) is '9870', and if you change the value, you should change the server program with the same value, so be cautious.

- ▶ [Terminal ID]: The terminal ID number uniquely identifies the terminal on the server program network. For every terminal on the server network you should program a different terminal number. This value should be 1-8 digits in length.

Note: If mobile key is enabled and the terminal is registered, the terminal ID can not be changed. Terminal ID is changed by the UNIS-B Plus administrator app when registering the device.

- ▶ [Timeout]: The default timeout is 5 seconds. When using server authentication, this period is the time in which the terminal will wait for a response from the server before timing out. The value is from 5 to 30 seconds.

*For static IP usage you must program the Terminal IP, Subnet Mask and Default Gateway. If DHCP is selected, these values cannot be programmed and will be grayed out. The port number must match the port number that is programmed in the Authentication Server.*



If you touch the item you want to change, the keypad appears at the bottom.

Select the  button to backspace/return to delete the current entry.

Select the OK button when finished the entry in the field.

If you want to apply the changes, select [OK] button, and return to the previous menu by selecting [BACK] button.

### 3.5. Application

#### 3.5.1. Application mode

If you select the [Application] in the main menu, the following window appears. In the application mode, you can select the [Access Control/ Attendance management/ Meal management] according to the purpose.

##### 3.5.1.1. Modes

###### Normal Access Mode

Function Key	Start Time	End Time
F1	08:00	08:00
F2	00:00	00:00
F3	08:07	08:00
F4	00:00	00:00
Access	00:00	00:00
Blocking Time (0-86400)	0	

It is the screen appearing when you select the Access.

Select [OK] button to apply the changes, or select [BACK] button to cancel and return.

An Access Control application is normally used for providing access to a secure area, function keys are not needed unless extra tracking of the user is needed. If the system is setup for Access Control and Function keys are used for authentication the user is required to touch the mode function key before entering their ID or card.

Time and Attendance Select [OK] button to apply the changes, or select [BACK] button to cancel and return.

Time schedules should be programmed when using this mode. Time and Attendance Application is for systems that require tracking of employee's work time. If the system is setup for Time and Attendance, for authentication the user is required to touch the function key before entering their ID or Card.

### Meal Management

It is the screen appearing when selecting the meal management.

You can set the time period of each meal type. And if the setting is not needed, set '00:00-00:00'.

►Allow duplicate: If it is unchecked () , each user can authorize once in the one meal, but if it is checked () , the multiple authorization is possible regardless of the previous authorizations.

Select [OK] button to apply the changes, or select [BACK] button to cancel and return.

►Schedule setting (00:00~23:59): You can set the time for each authorization mode and if you do not need the function, set '00:00 00:00'.



---

During the set time periods, the mode will change automatically to the time period setting. If a function key is pressed during the time period, the function key will change to the new mode, after 15 seconds the system will revert back to the current time setting mode.

i.e , if Period mode = Leaving mode, Function key -> Enter mode is pressed, after 15 seconds the mode will change back to Leaving mode.

The time periods should not be overlapped, but if they are overlapped, the application order is Attend->Leave->Out->In->Access. If the time is set between 23:00~01:00, it means from 23:00 to the 01:00 the following day.

- ▶Blocking time: This function prevents the same user to authorize again in the set time. There is no restriction if it is set 0, but if it is set larger than 0, the user can authorize again when the set time (sec) is passed from the previous authorization. It can be set up to 86,400 seconds (24 hours).

### 3.5.2. Function keys

The following window appears if you select the [Application] -> [Function key] in the main menu.

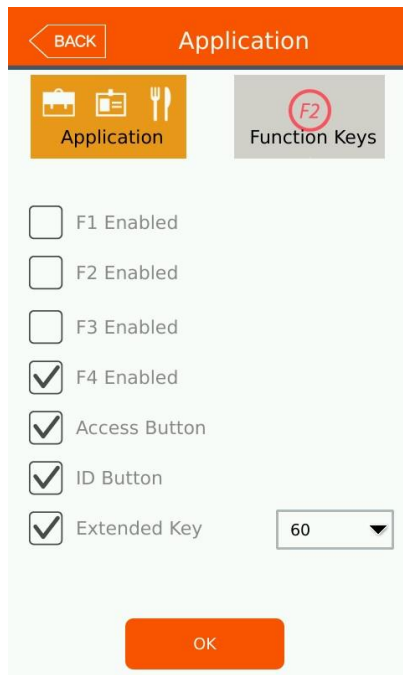

Application

Application Function Keys

F1 Enabled

F2 Enabled

F3 Enabled

F4 Enabled

Access Button

ID Button

Extended Key 60

OK

► Basic setting : Same with the window at the left side

►F1-F4 Key

Access button used to change the authorization mode such as attendance and leaving, and if you select the F1-F4 Key, the authorization mode is changed to the mode. Only the checked buttons will appear on the main window. Note: Only maximum 2 function keys will appear on the main window, any additional function keys will appear in the extended key window.

► In some cases additional function keys are needed in addition to the four main function keys. The administrators will setup the terminal for this operation. Up to 60 additional function keys are available. The extra function keys will appear in the extended view window from the main window.

4 – 60 extended keys can be selected.

Select the [OK] button to save the value or select [BACK] button to cancel and return.

---

### 3.6. System

#### 3.6.1. System

The following window appears if you select the [System] -> [System] in the main menu.

### ► User ID Length

The user ID length can be 2 to 8 digits in length. The user ID length will be the length of the user ID required to authenticate. The user ID length should be the same value that is programmed in the server software. Any place that requires the entry of a user ID will be restricted to the length that is programmed in this area. This value should reflect the amount of users in your terminal. For example, if you have fewer than 100 users than enter 3. If you have more than 10000 users, then program a 6 digit length.

**Note: When changing the ID length shorter than the previous programmed value; be aware that an administrator may not be authenticated properly to enter administrator programming if their**

**ID length was longer than the current length. It is recommended this value be changed at the time of setting up the terminal, and not during regular usage.**

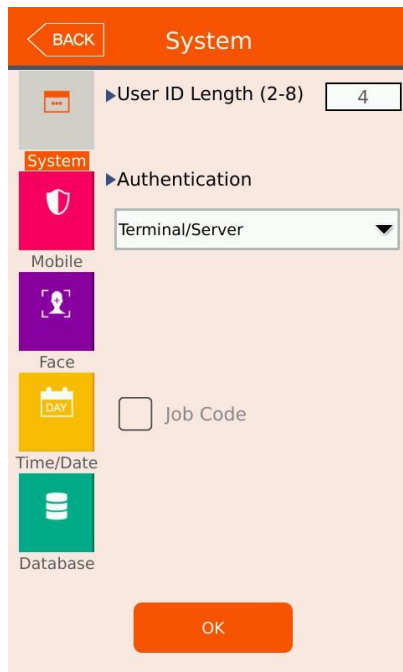

server.

### ► Authentication

One of Four options is available for the authentication mode. This setting determines where the user authentication is done, in the server or locally at the terminal, or both. Change this setting when there is high network traffic, many users, or authentication is too slow. The default setting is Terminal/Server

Terminal/Server – If the local terminal is properly connected to the network server, the authentication is done at the local terminal and the result is sent to the server in real time. However, if the user ID entered does not exist in the local terminal the authentication is requested at the

Server/Terminal - If the local terminal is properly connected to the network server, authentication is done in the server. If there is a disconnection or communication trouble between the server and terminal the authentication is done at the terminal.

Server Only – The authentication is done only at the network server.

Terminal Only – The authentication is done only at the terminal.

### ► Job Code

When this option is checked and a registered user is successfully authenticated, the user will be required to enter a 2-8 digit code as the final step. This can be any four digit code from 0-99999999. If the code is not entered when this checkbox is enabled authentication will be denied.

## 3.6.2. Mobile Key

The following window appears if you select the [System] -> [Mobile] in the main menu.

Basic system setup can be used to setup the card reader using smart phone administrator application or when using mobile key authentication with the smart phone user application.

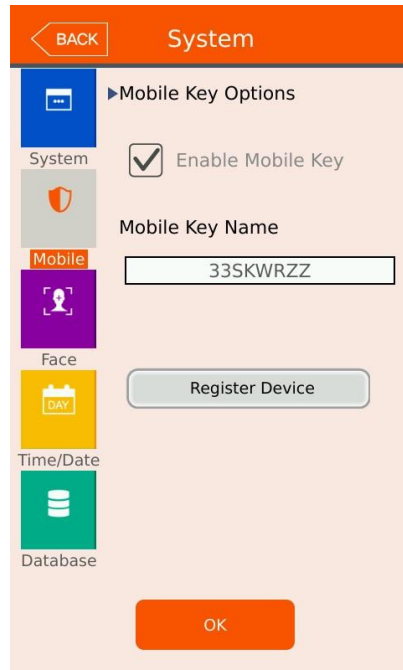

By default mobile key is enabled. If you do not require any Bluetooth mobile function you can select to disable.

Mobile Key Name – this is read-only field and is created automatically after registering the card terminal with the administrator smartphone application.

#### Registering Bluetooth Device

- 1) Select Add terminal (admin mobile app)
- 2) Select the terminal (admin mobile app)
- 3) Select Register Device button – this menu
- 4) Select login id or password if enabled. (mobile app)
- 5) Select terminal id (admin mobile app) 6) Complete.

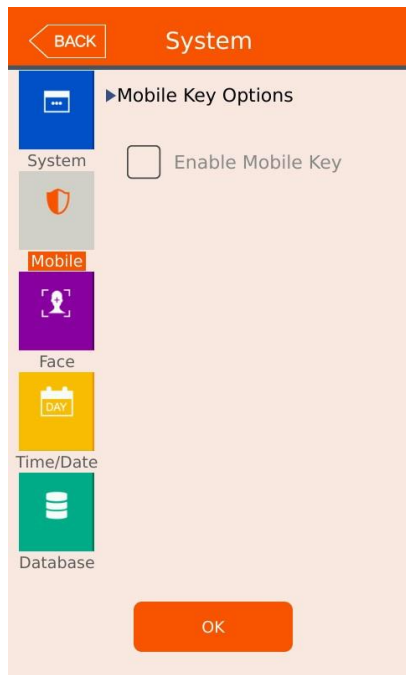

If mobile key is disabled, all mobile options will not be visible.

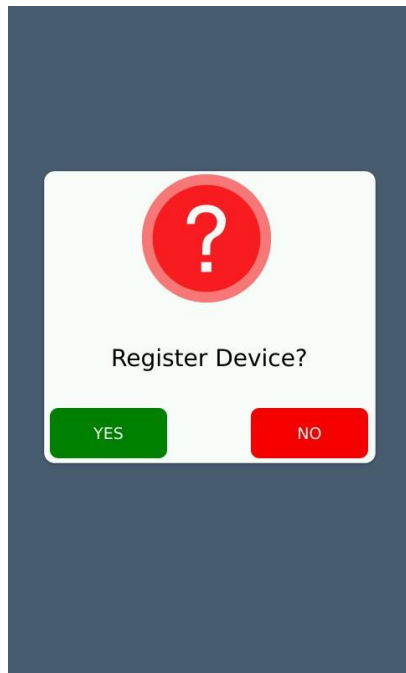

Confirm Bluetooth Registration  
Select YES

Waiting Bluetooth Registration



Administrator Mobile App requires login before continuing.

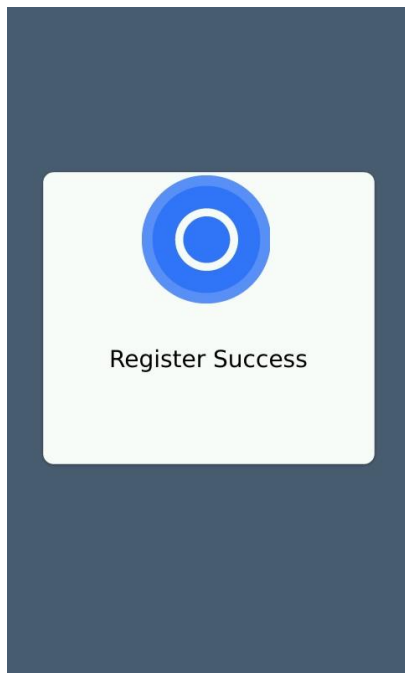

After Administrator Mobile App enters a terminal ID, the registration process is complete.

### 3.6.3. Face Detection

This feature is for detection of a face only; the terminal will not recognize a specific user's face with this function.

This feature can be used for all card users, all mobile users or all password users. After a card, mobile key or password is presented, the terminal will wait up to 10 seconds for a face to appear in front of the camera. If no face is present after 10 seconds the terminal will reject the transaction.

This feature can be useful when you want to force the users to show their face during authentication, in case of stolen cards, or lending cards to other employees during a time and attendance application.

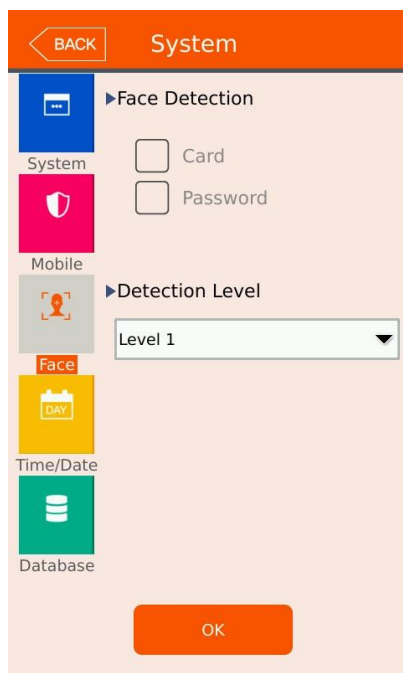

Select the checkbox for authentication types required for a picture during authentication.

Card, Mobile Key, Password.

By default this feature is disabled.

Detection Level

When one of the checkboxes above is selected, this defines the detail of facial detection.

- 1) Level 1 – Basic face , faster
- 2) Level 2 – Detail face , may take slightly longer

Select the [OK] button to save the value or select [BACK] button to cancel and return.



### 3.6.5. Time/Date

If you select the [System] -> [Date/Time] in the main menu, the following window appears.

#### ► Time Sync:

This is how terminal time/date is updated.

- Auto/Server – updated from the server. No need to set Date/Time below.
- Manual – set the time/date from this menu and the server will not update the time/date.

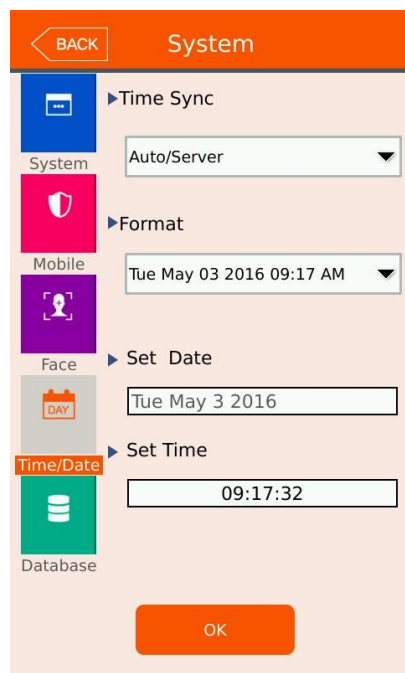

Note: When connecting with the Bluetooth/mobile key application, the terminal time/date is always updated.

#### ► Time Format:

The Date/Time Display Format will change the way the date and time is displayed on the main screen. Only English Language allows the selection of different formats. All other languages will only have Enable/disable, and the date will appear in their locale format. There are six choices:

- 1) Short form day (three letters), Short form month (three letters), DD, YYYY, HH:MM AM/PM (Thu, Mar 24 2009 08:19AM – no 24hour time, use AM/PM)
- 2) Short form day(three letters), same as 1, except use 24 hour time display
- 3) MM-DD-YY HH:MM AM/PM (03-24-09 08:19AM)
- 4) MM-DD-YY HH:MM (24 hour time) (03-24-09 23:44)

- 5) YYYY-MM-DD HH:MM AM/PM (2009-04-24 08:19AM)

6) YYYY-MM-DD HH:MM (24 hour time) (2009-04-24 23:44)

Setting Date/Time only required if set to 'Manual' in the time sync area.

▶ Set Date

▶ Set Time

Touch the area where the time is displayed. A number pad will appear. Enter the time in the format HH:MM:SS. (24 hour) For example current time is 11:14:00pm, enter '2' '3' '1' '4' '0' '0' and then press OK when finished. If a number is invalid or there is no entry, pressing OK will do nothing.

Select the [OK] button to save the value or select [BACK] button to cancel and return.

### 3.6.6. Database

If you select the [System]->[Database] in the main menu, the following window appears.

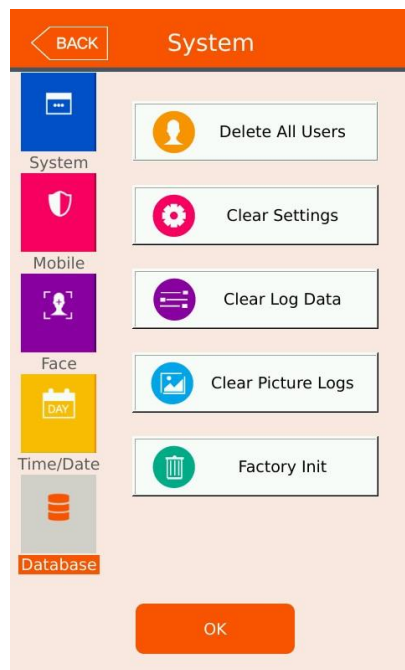

▶ Delete All Users: This option will allow you to delete all users in the system.

▶ Clear Settings: This option will clear/delete all the terminal settings. The factory settings will be used. User, log data and pictures will not be deleted.

▶ Clear Log Data: This option will clear/delete all the log data in the terminal. This will not delete picture log data or terminal settings.

▶ Clear Picture Logs: This option will clear/delete all the picture log data. The terminal can hold up to 70,000 pictures (user pictures + log pictures). If you need more user database pictures you can delete the picture logs.

▶ Factory Init: This option will reset the terminal settings, delete all the picture logs, delete all users and all log information.

---

Select the [OK] button to save the value or select [BACK] button to cancel and return.

#### 3.6.6.1. Database Confirmation

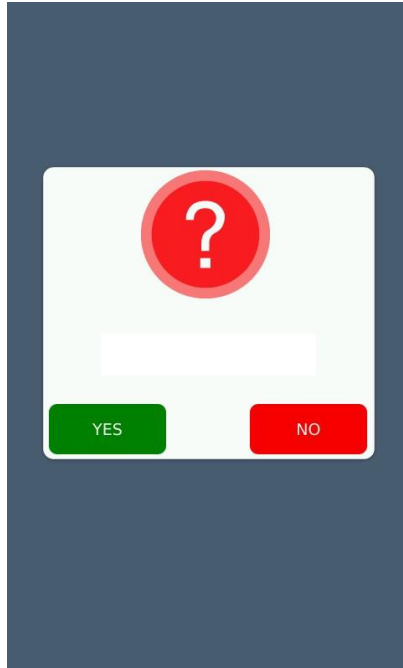

► A confirmation window will appear after selecting one of the selections from above.

Select YES to continue to delete or NO to cancel.

**Note: A backup of the user, system settings, pictures or logs should be done before erasing the data. Backup from USB device or system Server device.**

## 3.7. Terminal settings

### 3.7.1. Sounds

If you select the [Terminal] -> [Sound] in the main menu, the following window appears.

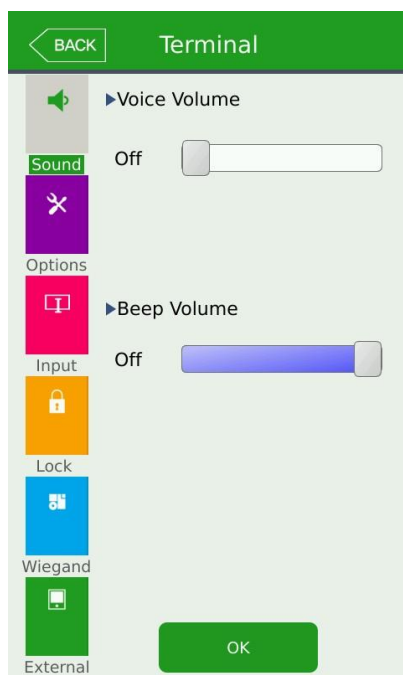

#### ►Voice volume

Scroll from side to side in to select the appropriate voice setting. A voice will be played after releasing the selector to determine the volume. Slide all the way to the left to disable voice prompts. Default is OFF.

4 Voices are used

- 1) You are authorized (Success)
- 2) Please Try Again (Failed)
- 3) Enter your Card
- 4) Enter your ID

This value determines sound level of:

- Error tone wave
- Success tone wave
- KeyPress tone wave
- Other sound effect tones

If Voice volume is OFF, then all sound effect tones will follow beep volume setting value

#### ►Beep volume

Scroll from side to side to select the beep volume.

Selectable area from 4 types. Default is 2

- 0 (off)
- 1 (low)
- 2 (medium)
- 3 (high)

#### ►User voice

If the user wishes to change the voice played when the authorization is successful or failed, you can import new voices using USB function. See USB section

Select the [OK] button to save the value or select [BACK] button to cancel and return. If you want to set another item, select the menu you want to change at the left side.

### 3.7.2. Terminal option

If you select the [Terminal]->[Terminal option] in the main menu, the following window appears.

#### ► Card Reader

If you scan/touch your card to the terminal, the terminal will beep and display the card number. The card number

depends on the card format selected from the Card Format option below. Default is Standard

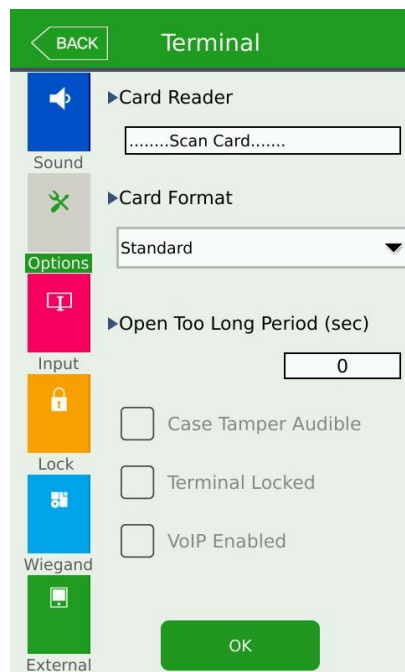

#### ► Warn door open (sec) 0-99

Default 0 - disabled

This function will produce a warning tone after the set time when the door remains open after an access to the terminal. To use the function, the lock must be able to be monitored if it is opened or closed, and the monitoring pin of the lock also should be connected with M0, and set for Door Monitor NO or NC.

#### ► Case Tamper

If this option is enabled and the case tamper on the back of the terminal is 'opened' (terminal removed from the wall), an error sound will be heard every 5 seconds when the main window is displayed. During administrator programming this sound does not occur. Also, if a case tamper occurs the status icon for 'trouble' will always be displayed on the main window. See Icon list for details. Default enabled.

#### ► Lock terminal

This function enables the administrator to lock or unlock the terminal directly on the terminal, not on the server program. If it is checked () , the main window will display 'Locked' status. No authentication is possible during this time. Default disabled

► VoIP

Voice Over IP enabled. Default is disabled.

► Card format

Card format determines how the card data is converted once it is read from the terminal. Note: If you change the card format, you must re-register all card users in the device. When registering a user in the terminal, this value should be set, considered first. Also we registering a user from the server, the card format at the server must match the terminal format.

The card number is converted according to the following settings.

RFcard EX) Card number (5byte): 08h 01h 16h 1Dh D6h

Card format	Card number	Expression
Standard	02207638	(3+5)digits decimal [022(16h)+07638(1DD6h)]
Hexadecimal	0801161DD6	10digits hexadecimal
10 Digit Decimal	0018226646	Posterior 4byte: 10digits decimal (01161DD6h)
3,5 Digit Decimal	02207638	Same with [Standard]

SCcard example) card number(4byte): 52h 9Dh 06h E3h

Card format	Card number	Expression
Standard	529D06E3	8 digits hexadecimal
Hexadecimal	E3069D52	8 digits hexadecimal with changing the order of byte

---

10 Digit Decimal	1386022627	hexadecimal 529D06E3: 10 digits decimal
3,5 Digit Decimal	3808861522	hexadecimal E3069D52: 10 digits decimal

---

Select the [OK] button to save the value or select [BACK] button to cancel and return.

### 3.7.3. Terminal Input

If you select the [Terminal] -> [Input] in the main menu, the following window appears.

The Terminal has the ability to monitor the physical lock and/or door state when the door is open and closed, or terminal can be used to monitor status of another external device. See the installation guide for details how to connect.

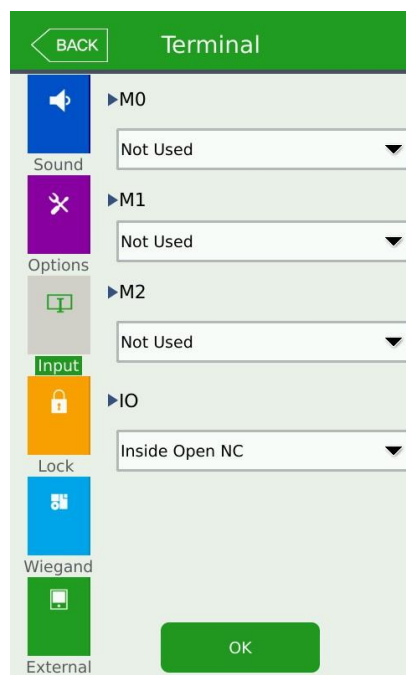

► Default Setting : M0-M2 not used, IO (Inside Open)

The inputs accept a relay input either Normally Closed or Normally Open. You should program the input according to your relay activation type. (NC or NO). It is recommended that not more than one of the same option is used. For example do not program M0 for Door Monitoring and M1 for Door Monitoring.

Normal Connection

- M0 – door monitor
- M1 – lock monitor open
- M2 – lock monitor closed

These are the available types of monitoring options:

- Disabled – If you do not use the input for anything select this options
- Door Monitor (NC/NO) – if you are connecting a door monitoring device select this option. The terminal will monitor when the door is opened and closed.
- Lock Monitor (NC/NO) – if you are connecting a lock that can be monitored when the lock is opened select this option. If the lock has an error opening the terminal will sound an error tone. (Normally used for Motor Lock Monitoring when lock is opening)
- Lock Monitor 2 (NC/NO) – When using a motor lock use this option to monitor the motor lock closing status. Only use this selection for motor lock monitoring.
- Inside Open (NC/NO) – if you would like to connect a Request to Exit device, door open button select this option. Usually if the terminal is on the outside of the door, this door open button or Request to Exit is connected inside the door. The button is pressed the terminal will unlock the door.
- Host (NC/NO) – This option is used to disable the terminal from access. In applications where you have an external controller or terminal that should be accessed first before the card reader you can use this option. If input is not activated, the terminal will not accept card, mobile or id input; when the signal from the external device is de-activated the terminal will allow access. This can be used in situations where the guard terminal is the master terminal, when the guard approves the access, then the output will trigger the card reader to allow authentication.
- Fire Monitor (NC/NO) – If you have an external device that has a fire output, the terminal will monitor when the device detects a fire alarm. The terminal will show a fire icon and give an audible warning tone; if any doors are connected to the terminal the terminal will open the doors. When this signal is activated, the server software will also be notified of the fire signal to alert other terminals connected on the network.
- Wiegand Mode (NC/NO) – If using wiegand output, this input can be used to verify the external controller acknowledged the card data that was sent on the wiegand output.



---

i.e Card Scanned at terminal, card data sent to external controller using standard wiegand output, the terminal will wait until the external controller sets this input high or low to acknowledge the card was accepted by the controller.

Select the [OK] button to save the value or select [BACK] button to cancel and return.

#### 3.7.4. Terminal Lock

If you select the [Terminal] -> [Lock settings] in the main menu, the following windows appear. See the installation guide for details how to connect a lock to the terminal.

► Default Setting: Same as the window on the left.

► Lock 1 and Lock 2 Open Time (milliseconds)

Lock activation times can be programmed from 300ms to 999999ms. (maximum is 99.999=100 seconds)

### Lock 1 and Lock 2 Options

- Not Used – select this option if not using the lock outputs
- Authorized – select this option if you want to provide an output signal when a user is authorized. i.e. Lamp Signal
- Unauthorized – select this option if you want to provide an output signal when a user is unauthorized. i.e. Lamp Signal
- Trouble – select this option if you want to provide an output signal when the terminal has a trouble condition, the only monitored trouble condition is 'case tamper'. An external controller can be notified when this event occurs. If a door is forced open this output will also activate.
- Motor Lock 1 – Select this if connecting a motor lock to the terminal to control when the lock is opening.
- Motor Lock 2 – Select this if connecting a motor lock to the terminal to control when the lock is closing.
- Strike/Auto – Select this if connecting a strike type or auto door lock to the terminal.
- Scheduled – In the server program if you program the schedules and send the schedule to the terminal, the terminal will activate the output when the schedule becomes active. This can be used to turn on an external device during specific times of the day for a specific duration.

#### Note:

For motor lock settings normally two outputs are used. You should select Motor Lock 1 for Lock 1 and Motor Lock 2 for lock 2. The terminal will automatically set Lock 1 and Lock 2 if you program for Motor Lock.

### 3.7.5. Terminal Wiegand

If you select the [Terminal]->[External device] in the main menu, the following window appears.

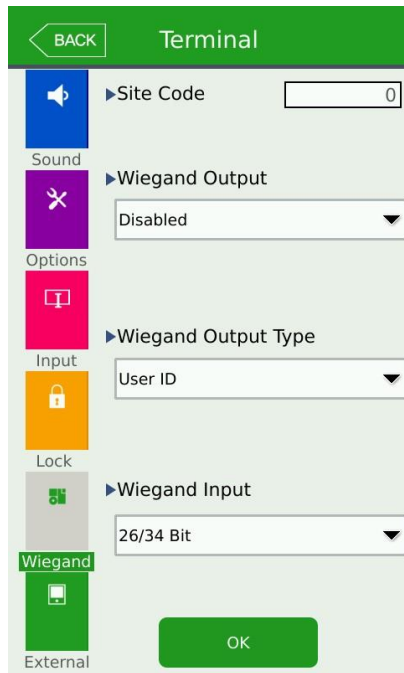

► Default Setting: Same as the window on the left.

#### ►Site code

It sets the sitecode value sent in Wiegand output below.

When the authorization is successful, the data of the following format is sent to the Wiegand port of the terminal.

#### ►Wiegand Input

Standard wiegand is 26 or 34 bit. The terminal is always waiting for wiegand input, up to 34 bits.

Use Terminal option, card reading to view the card number received at the wiegand input. If the format of the data is incorrect it must be setup using the server program.

#### ►Wiegand Output

This is only used when connecting the terminal to an external controller to notify the controller with card data or user id that was used. Standard wiegand output is 26 or 34 bit. If any other format is needed, the setup must be done using the server program.

Wiegand Output type can be set for User ID, Card Number or Unique ID.

None	General case. It does not use Wiegand out port.
26bit	Sending "Sitecode[1byte] + User ID[2 byte]", set the user ID less or equal than 4 digits. Send example) In case of SiteCode:045(2Dh), UID:6543(198Fh) → 1 00101101 0001 1001 10001111 0

34bit	Sending "Sitecode[1 byte] + User ID[3 byte]", set the user ID less or equal than 7 digits. But, if the user ID is 8 digits, ignore sitecode and send only the "User ID[4byte]". Send example) SiteCode:001(1h), UID:123456(1E240h) → 0 00000001 00000001 11100010 01000000 0
Custom When	the server program sets the wiegand output to other value than the standard 26/34 bit, this is displayed. This type can only be selected and setup using the server program.

Select the [OK] button to save the value or select [BACK] button to cancel and return.

### 3.7.6. Terminal External

If you select the [Terminal]->[External device] in the main menu, the following window appears.

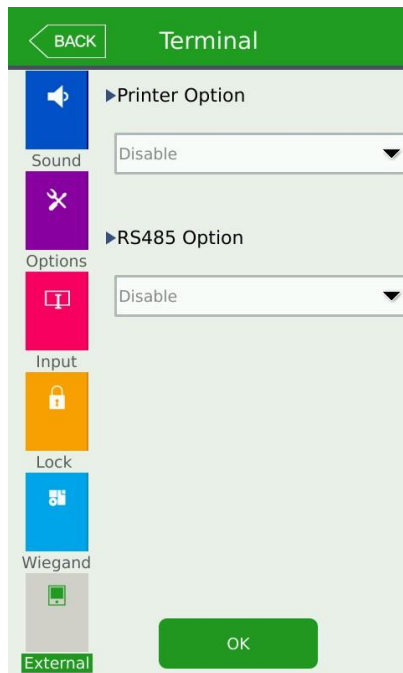

▶ Default Setting: Same as the window on the left.

See Installation Guide Section 11 for connecting a serial printer.

▶Printer Option

Disabled – select this if not using T/A Ticket – if using Time and Attendance mode and require a printout every time authorization occurs. Meal Ticket – if using Meal Mode and require a printout every time authorization occurs. The printing format differs as per each setting. The final result (time/date, mode type, etc) will be printed. The printer used must be only SRP-350 serial type model.

See Installation Guide Section 12 for connecting an RS485 bus.

▶RS485 Option

Disable – select this if not using LC010/BLC – Select this when using Viridi LC010 or BLC015 external lock controller. Controller – Select this when using OSDP protocol to an external controller.

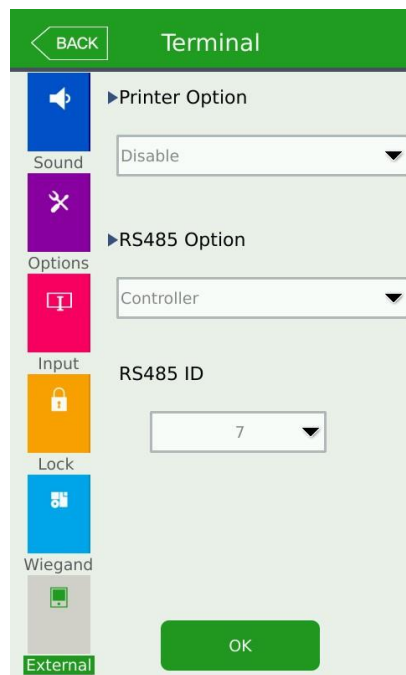

#### ►RS485 Option

If 'controller' is selected for the RS485 Option, a RS485 is required to connect to a RS485 protocol bus. You should select an appropriate id from 0-7,. Controller selection will work with a standard protocol called 'OSDP'; this is a SIA Industry standard protocol.

Select the [OK] button to save the value or select [BACK] button to cancel and return.

### 3.8. Display settings

#### 3.8.1. Theme

If you select [Display] -> [Theme] in the main menu, the following window appears.



► Default Setting: Same as the window on the left.

►The main background.

Main background is displayed on the main window or when screen saver mode is enabled.

Cycle forward or back through the available backgrounds. 15 factory set backgrounds are available to choose from. If you import your own background it will also be selectable from this area. See USB->Theme import.

►Cycle (seconds)

Values from 0-255. This time in seconds is the interval in which the background will change to a new background. If 0 is programmed, then the background will remain at the current picture. If 255 is programmed the background picture will change everyday at midnight. Anytime between 0 and 255 is the number of seconds the background will change. If you have user background images, the terminal will cycle through only these images. If no user background images are

in the terminal, the factory background images will be used.

Select the [OK] button to save the value or select [BACK] button to cancel and return. If you would like to select another items, select the menu you want to change on the left side.

#### 3.8.2. Camera

If you select the [Display] -> [Camera] in the main menu, the following window appears.

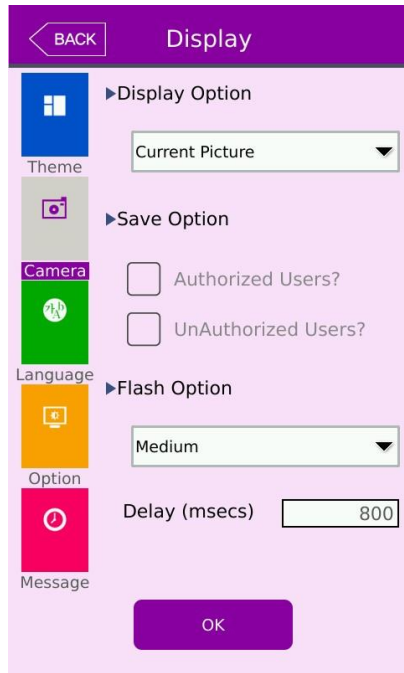

► Default Setting: Same as the window on the left

►Display option

- None ( no user picture is shown on result window)
- Current Picture ( current user picture is taken and displayed on result window)
- User Picture (Registered database photo is displayed) If no registered photo, or the authentication is unsuccessful, no picture result is displayed.

►Save success log

If it is checked () , the camera image is captured as image log when the authorization was successful.

►Save failed log

When it is checked () , the camera image is captured as image log when the authorization was failed.

Select the [OK] button to save the value or select [BACK] button to cancel and return.

### 3.8.2.1 Camera Flash Option

The camera used for still pictures or face detection also has an optional flash to use during dark conditions. There is a built-in sensor to detect dark and light conditions. You can select to turn off the flash if you do not need it.

Depending on the dark conditions you can set the flash to different levels of brightness.

1. Low
2. Medium
3. High.
4. Off/Not used

Delay (milliseconds) is programmable from 200ms to 2000ms. This can also be referred to as exposure time. The amount of time required for the flash to turn on before taking the picture. Depending on the environment the administrator may need to adjust this exposure period.

### 3.8.3. Language

If you select the [Display]->[Language] in the main menu, the following window appears.

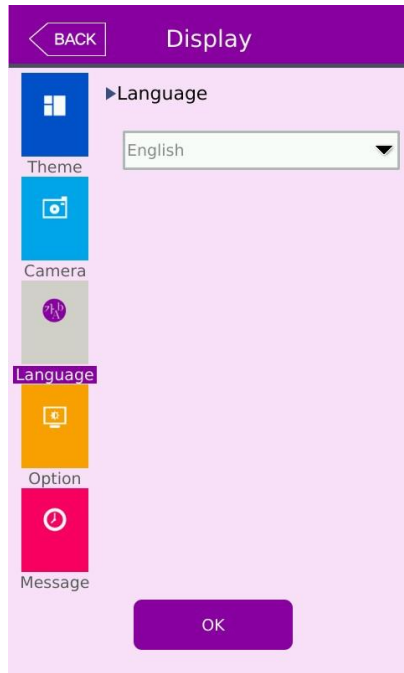

▶Default Setting: 'English'

▶Language

If you change the language and select 'OK' button, the voice message and language are changed to the set language.

Select [OK] button to apply the changes, or select [BACK] button to cancel and return.

※Supporting languages

English, Korean, Japanese, Thai, Spanish-Portugal, Spanish-Spain, Farsi(Persian), Deutsch, Chinese, Taiwanese, Polish, Slovenian.

### 3.8.4. LCD option

If you select [Display] -> [LCD option] in the main menu, the following window appears.

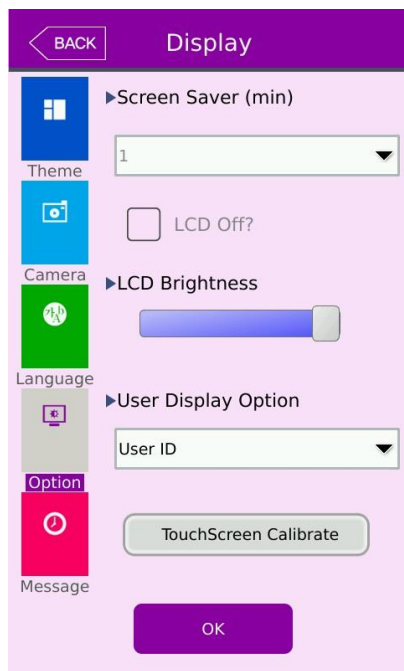

▶ Default Setting: Same as the window on the left

▶Screen saver (min) (1 minute ~ 30minutes)

Select the appropriate timeout you wish to use. If you do not want a screen saver after a timeout select 'off'. ▶ If screen saver is not set to 'off', when this option is unchecked the normal background image will show with the time & date only when the screen saver timeout occurs. When this option is checked the LCD will turn off after the screen saver timeout.

▶LCD Brightness

Adjust the brightness of the LCD with this setting.

▶User display option

When a successful user is granted access this will be displayed on the main window, popup.

- None
- User ID

- Key ID (Employee ID entered from the server program)

- User Name



►TouchScreen Calibrate – if the Touchscreen seems misaligned or not exactly to the users alignment you can readjust the calibration, a reboot will occur and guide you through the instructions.

Select the [OK] button to save the value or select [BACK] button to cancel and return.

### 3.8.5. Message time settings

If you select the [Display]->[Message time setting] in the main menu, the following window appears.

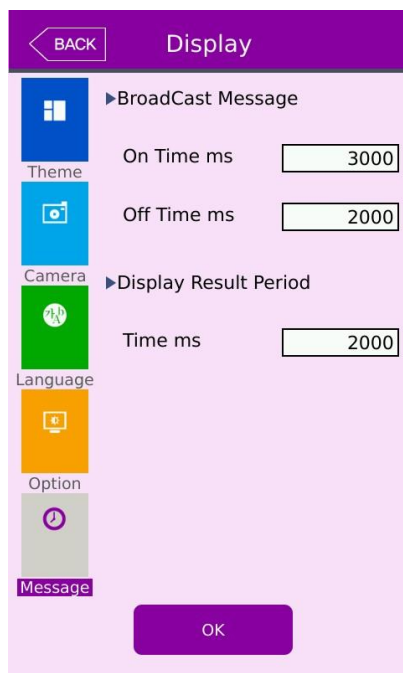

► Default Setting: Same as the window on the left

►Message display (ms unit)

It sets the time for which the authorization result window to be displayed.

0~5000 is available for the value, and the authorization result window appeared and disappear for the duration. Because it is set in ms unit, if you want to set 2 seconds, you should set 2000

►Broadcast Message (ms unit)

From the UNIS server program you can send a message to the main display. The message will flash on and off depending on the values for the ON time/OFF time. Message will be displayed from the time period set in the UNIS program.

Select the [OK] button to save the value or select [BACK] button to cancel and return.

### 3.9. Terminal information

#### 3.9.1. System information

If you select the [Terminal info] -> [System] in the main menu, the following window appears.



#### ►System info

The hardware and firmware version of the terminal is shown.

- Card Reader status
- Camera status
- Bluetooth status
- BLE serial number

#### ►System Storage (using/all)

Usage of system data.

#### ►Ram (use/total)

Usage of DDRAM.

Select another selection on the left side or CLOSE, BACK button to return to previous window.

### 3.9.2. Terminal information

If you select the [Terminal information] -> [Terminal] in the main menu, the following window appears.

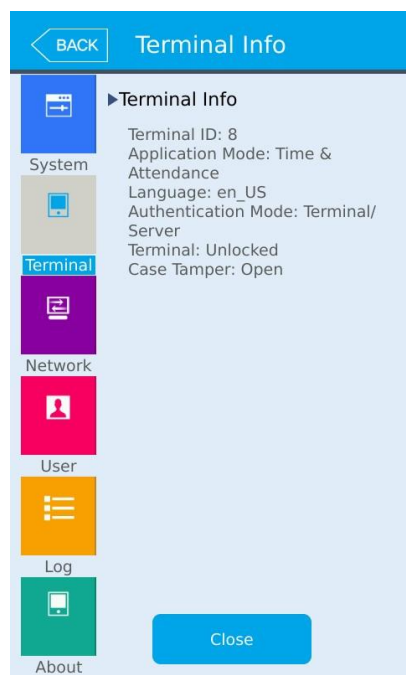

#### ►Terminal information

Displaying basic information about terminal setup

Select another selection on the left side or CLOSE, BACK button to return to previous window.

### 3.9.3. Network information

If you select the [Terminal information]->[Network] in the main menu, the following window appears.



#### ►Network information

Displaying basic information about network information.

Select another selection on the left side or CLOSE, BACK button to return to previous window.

#### 3.9.4. User information

If you select the [Terminal information]->[User] in the main menu, the following window appears.



►User information

- Registered Users: The number of users registered (including administrator)
- Administrator Users: The number of the administrators registered.
- Card: The number of cards registered
- Capacity: (Max means the maximum number )

Select another selection on the left side or CLOSE, BACK button to return to previous window.

### 3.9.5. Log information

If you select the [Terminal information] -> [Log] in the main menu, the following window appears.

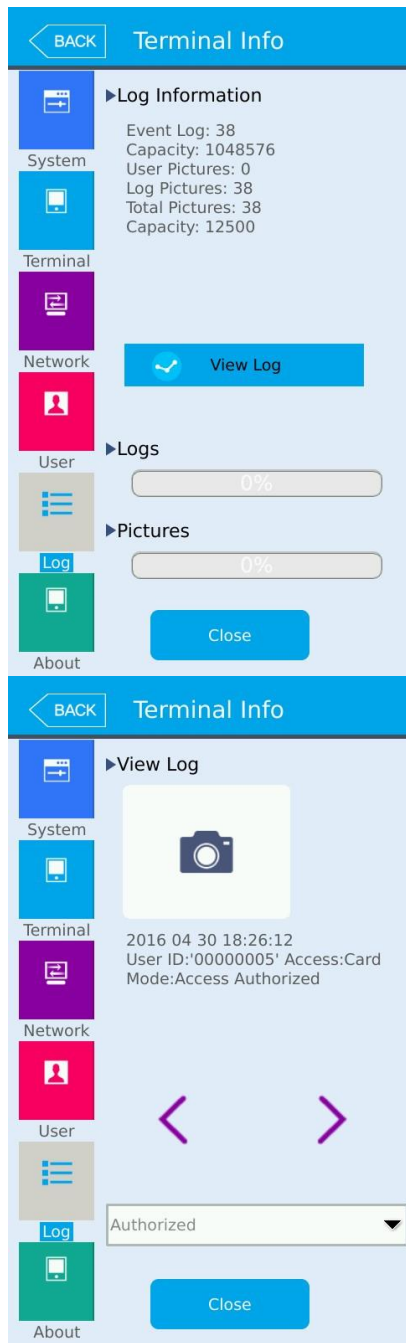

►Log

Event Log: The number of logs saved in the terminal  
 User Pictures: Number of registered user pictures  
 Log Pictures: Number of log pictures  
 Total Pictures: User and Log picture total  
 Capacity: (Max means the maximum number )



►View Log

Displays log time and authentication result  
 Select 'View Log' to find search results.

► Log Search result

Log search result shows the information such as the date, time, ID and access result (success or failure).  
 If a picture is saved with the log, the picture is also shown.



Select  OR  button to see the search information.

Select another selection on the left side or CLOSE, BACK button to return to previous window.

3.9.6. About

If you select the [Terminal information] -> [About] in the main menu, the following window appears.

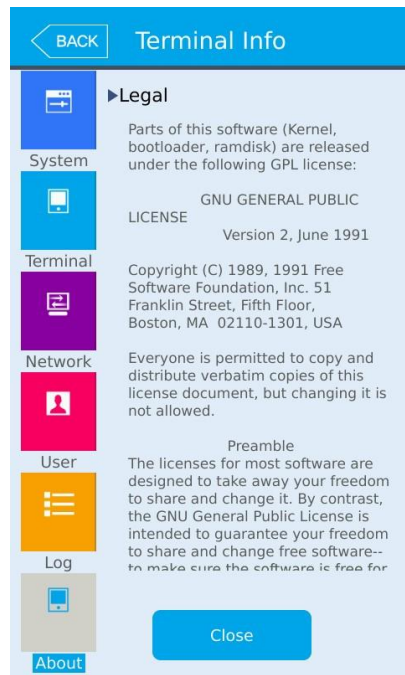

#### ►About

Display legal information about software and firmware

Select the text area and scroll up or down to view more

Select another selection on the left side or CLOSE, BACK button to return to previous window.

### 3.10. SD USB

SD (Storage Device) USB on-The-Go function is supported in the card reader terminal. You will need a cable as shown below. USB storage function will allow you to import and export files to and from the terminal.

User data, log data, pictures, images and firmware upgrading can be performed. It is recommended that your USB has at least 1GB available for storage. You cannot select any options in the USB-SD menu until a USB device is connected. The USB device can be connected at anytime before or after entering this area. Once you connect your device you must wait up to 10 seconds before the terminal will recognize it and a 'detected' message will appear. The USB should be formatted as FAT/FAT32 file system type. NTFS is not supported.





- 1) Prepare your USB device by formatting for FAT/FAT32 File system type
- 2) On the USB device from your PC, create a directory in the root called 'CR'
- 3) On the USB device from your PC, create a directory in the root called 'CR/languages'
- 4) On the USB device from your PC, create a directory in the root called 'CR/backgrounds'
- 5) On the USB device from your PC, create a directory in the root called 'CR/firmware'
- 6) Insert the USB into the cable, and then insert the cable into the card reader.
- 7) On the card reader menu Touchscreen select the USB icon.
- 8) After completing import or export you must select OK button to correctly save the information to the USB device.
- 9) Remove USB device.

**Note: After selecting OK you must remove, then insert the USB device in the card reader before entering the USB menu again. This will ensure correct saving and shutdown of the USB device.**

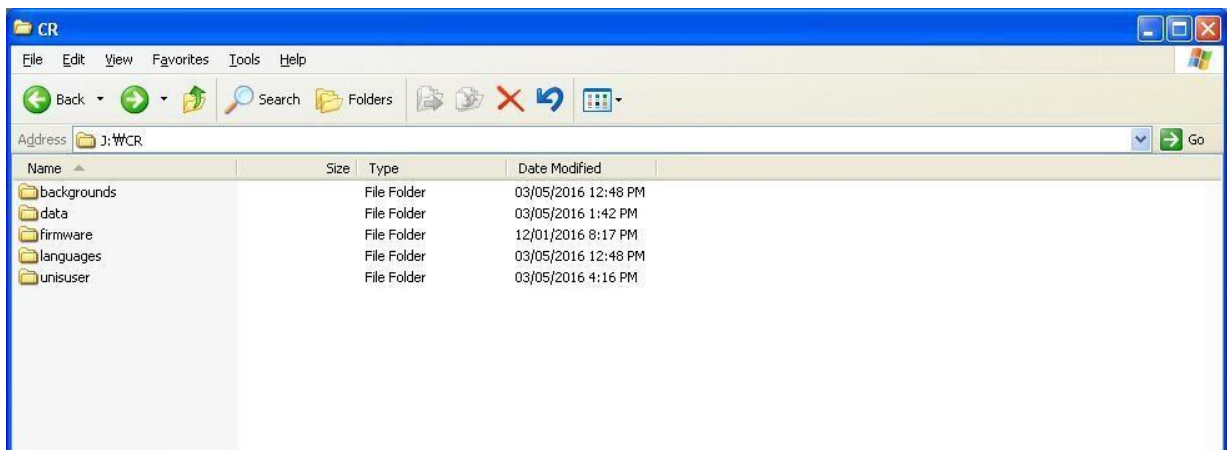

Filenames maybe in the format.

(XXXXXXXX\_YYYYMMDDHHMM\_logdata.tar.gz)  
(XXXXXXXX\_YYYYMMDDHHMM.csv)  
(XXXXXXXX\_YYYYMMDDHHMM\_picologdata.tar.gz)

XXXXXXXX = terminal ID

YYYYDDMMDDHHMM – Year, Month, Date and Time of export.

Note: .tar.gz are tarballed compressed zipped files. If you are using windows PC you may need to download a utility program to extract the files. If you are only saving, and importing to another terminal, you should not rename the file.

**'CR/languages' directory** – Card Reader language files are in this folder. Only .qm file extensions supported. Card Reader language files are in the format lang\_en\_US.qm (For example English)

A separate program is used to create the language translation file for each language.

**'CR/languages/mp3/' directory** – Card Reader mp3 voice files can be updated by USB. There are 4 voice files that can be upgraded and they must be named as follows:

- 1) E02\_PleaseTryAgain.mp3 (Failure voice)
- 2) E03\_YouAreAuthorized.mp3 (Success voice)
- 3) E04\_InputYourID.mp3 (Enter ID voice)
- 4) E05\_PleaseEnterYourCard.mp3 (Enter Card voice) Note: Each file should not exceed 100kbytes.

**'CR/firmware' directory** – Store all firmware files needed for upgrade in this folder. From time to time the factory will release new firmware versions for bug fixing or feature enhancements. These binary images can be upgraded from this folder. Correct file names should have a '.umgz' extension.

- resource.umgz
- app.umgz

**'CR/data' directory** - This directory is created by the card reader terminal when inserting the usb device. This directory will contain data that will be exported to the usb device. (User data, log data, system options, picture data)

- 1) sysoptdata.tar.gz (Import file for other card reader terminal)
- 2) 00000008\_201605031340\_logdata.tar.gz (Log Data for Server Program Import)
- 3) 00000008\_201605031340.csv (Log List short)

**'CR/backgrounds' directory** – this should contain all .jpg, .bmp, .png images you would like to copy to the terminal for your own background images. The name of the file must be called user1 – user9 (.jpg) or (.bmp) or (.png)

For example if copying four image files to the terminal you should call the image files user1.jpg, user2.jpg, user3.jpg and user4.jpg.

---

In order to ensure a quality background image you should use the same size as the lcd device, 480 x 800. After successfully copying you will be able to select a new background from the Display setting area.

**'CR/data/logpictures' directory** – This directory is created by the card reader terminal when exporting log picture data to the USB device. i.e - 00000008\_piclogdata.tar.gz

**'CR/unisuser' directory** – This directory is created by the card reader terminal when selecting Export User Data. Files in this directory will be named 0000.dat~9999.dat.

These files can be used to import from another device or import to the server program on a PC.

If you select the [SD USB] from the admin menu, the following screen appears.



No USB device Connected

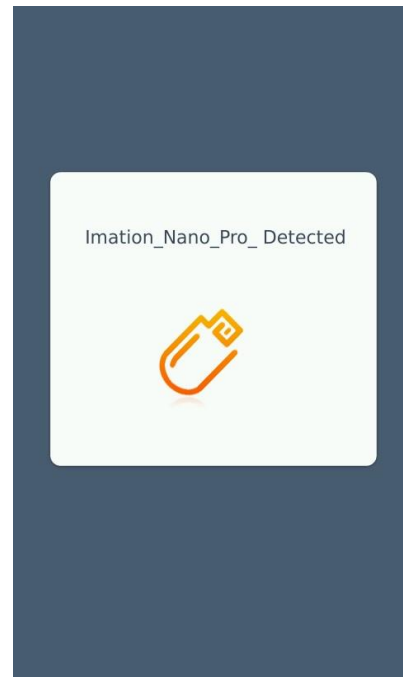

USB Device Connected with brand name

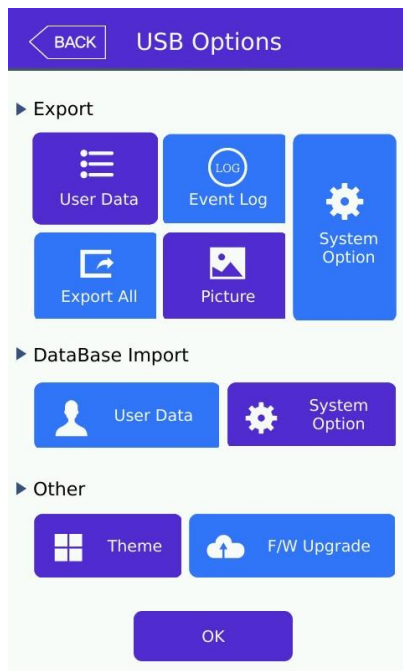

### USB Function

Import is used to importing user data or system options from another device.

Export is used for saving user, event, system options or log picture data. After exporting you may import User data or System Options to another device.

### Other

Special functions such as backgrounds, language files may be copied to the card reader terminal.

F/W upgrade can also be performed from the USB device. If server program is connected is it recommended for speed and reliability to use the server program.

### 3.11. Background screen change

If you select 'download customized file' from the UNIS server program you will be able to select 'All File'. UNIS 4.0 and above only.

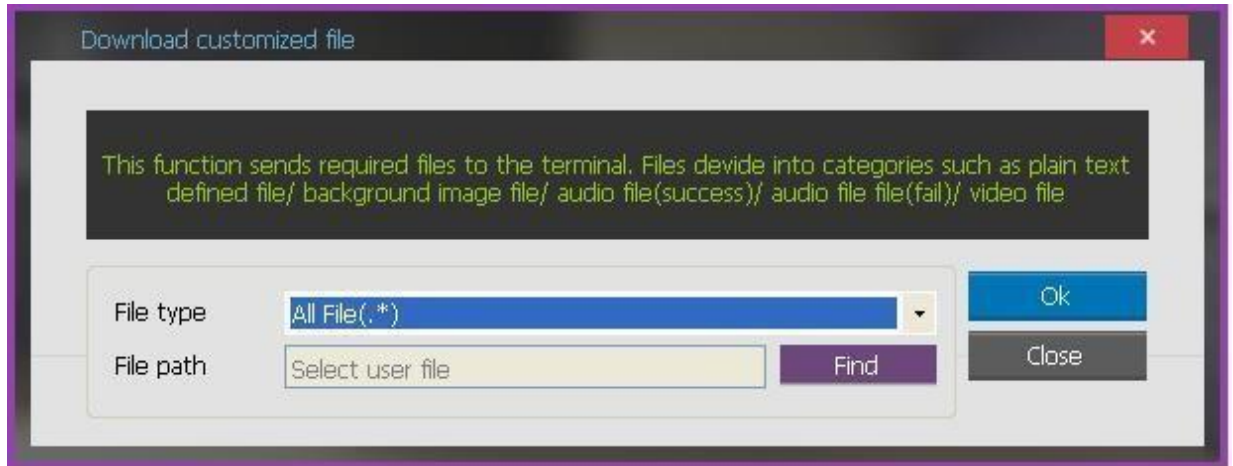

Select

.jpg, .bmp, .png Images only

The file name should not exceed 15 letters (English).

The file name should be in the format user1-user9.xxx – (xxx=jpg, png, bmp) The file format MUST be an appropriate size to fit the screen 480 x 800.

If you select the file type as 'All File (\*.\*)', Select 'Find', then select the image file and select the 'OK' button, the terminal selection window appears. If you select the terminal in the terminal list window and click the 'Send' button again, the file is sent and downloaded to the terminal.

You can manually select the background images from the 'Display Settings' -> Theme menu from the administrator menu.

### 3.20. Language Translations/Customizing Text Items

Mostly all text on the user interface can be changed or customized to your customer's choice. Language must be in the ISO639 format naming is required.

xx\_YY – xx = Language  
YY = Region/Country

lang\_en\_US // English/US  
lang\_ko\_KR // Korean

---

lang_ja_JP	// Japan
lang_zh_CN	// Chinese
lang_zh_TW	// Chinese (Taiwan)
lang_de_DE	// German (dutch)
lang_it_IT	// Italian
lang_zh_TW	// Taiwan
lang_fr_FR	// French
lang_fa_IR	// Farsi - Iran ( persian )
lang_ar_EG	// Arabic - Egypt
lang_es_ES	// Spanish Spain
lang_es_EC	// Spanish Equador
lang_pt_BR	// Portuguese Brazil
lang_pl_PL	// Polish
lang_th_TH	// Thai, Thailand

TS File = from the factory, given to the customer for translations

QM File = created by the application program. Used by the card reader terminal.

Example:

lang\_en\_US.ts – supplied by the factory lang\_en\_US.qm – output file

created for use by card reader terminal

1) Download the translation tool from the following link

<http://www.qt-apps.org/content/show.php/Qt+Linguist+Download?content=89360>.

The user should download the appropriate one for their pc.

2) Install the application on your PC. User should read the instructions on how to translate. Select the input file to start from (TS), select the individual text, then type into your own language.

3) Once the application is opened, you should go to FILE->OPEN-> and open the lang\_xx\_YY.ts file. These files are available when a firmware release is made. Once the user completes the translation they need to click on the FILE->RELEASE AS, this will save the file as lang\_us\_EN.qm. The QM file is used by the card reader terminal. If we require a special language the user should send the factory the TS file.

User should then copy the QM file to a USB device in '/CR/languages/'. See the SD USB section.

If you select 'download customized file' from the UNIS server program you will be able to select 'All File'. UNIS 4.0 and above only.

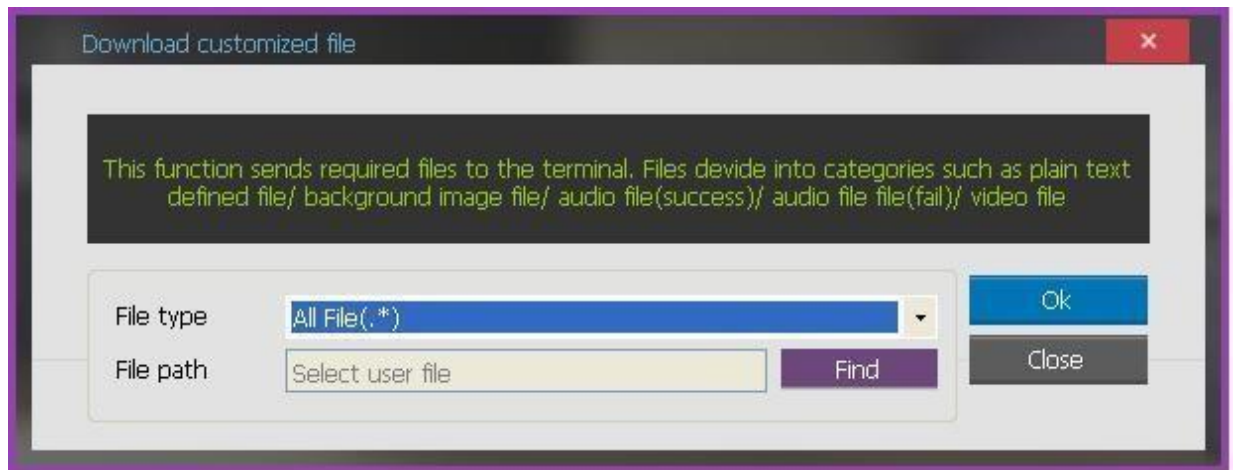

You can upgrade the new .qm file using the following two ways:

- 1) USB – see section 3.10. SD USB for updating using USB
- 2) UNIS – from UNIS, select 'download customized file', the select 'All File (\*.\*)', browse to the language file and select it. Select OK, and then select the terminal to send to.

Language files must be in the naming format 'lang\_xx\_YY.qm'.

**Note: Some languages not on the list above require special fonts to be imported. You must contact your sales representative if you wish use use a language not supported on the list.**

**Note: When you upgrade firmware 'resources\_xxxxx.umgz' all language .qm files will be overwritten with the factory .qm files.**

#### 4. How to use terminal

The background image and composition of the main window can be changed according to the administrator's setting. In addition, if the administrator set the screen saver time, the LCD screen will show only the background image with the time and date. Entering a card, touching the screen will change back to the main window.

##### 4.1. Authorization mode change



<Fig. 4-1>

Press [F1], [F2] button on the screen changing the verification/logging mode.

In order to select the mode other than the ones on the screen, such as ([F3], [F4], [Access]),

press the button  which is on the right side of the screen and the screen as per below will appear.

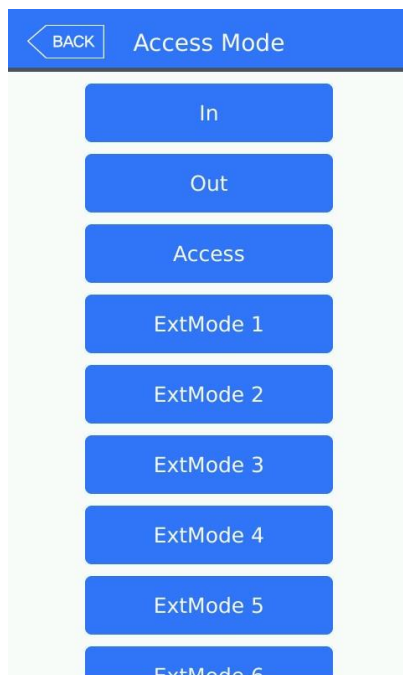

In the access mode selection screen, as shown in the left, select the preferable access mode button, which the screen will move to the selected access mode.



## 4.2. ID input



If you select the [ID input] button on the main window, the following ID input window appears.

Enter the user ID to be certified and select [OK] button, and then scan your card or enter your password according to the authorization method of the user.

## 4.3. Authorization

### 4.3.3. Card authorization

Touch/Scan the card on the area of the card reader as shown in <Fig. 4-1>

### 4.3.4. Password authorization

Input your ID by selecting [ID input] button as follows and input password when the password input window appears.

