

ARMARIOS PC



ES

- Armario modular para PC.
- Para pantallas planas de hasta 23".
- Configure su armario según sus necesidades.
- Disponible con o sin ruedas.
- Disponible conexiones eléctricas y de datos.
- Colores en opción.
- Material informático no se suministra.



SERIE 104 ref. 104 0 / 104 1

Armario PC opción con puerta o persiana.
Armoire PC option avec porte ou rideau.
PC cabinet with option door or shutter closure.



104 0



104 1



104 0

Puerta de metacrilato.
Porte de méthacrylate.
Methacrylate door.

104 1

Persiana y bandeja extraíble.
Rideau et plateau amovible.
Shutter closure and removable tray.

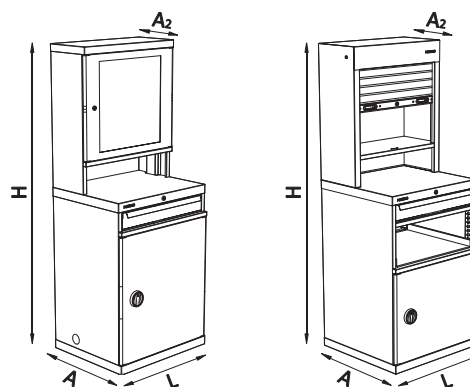

RUEDAS ROUES WHEELS

Ø 100 mm



COLORES COULEURS COLOURS

Colores estándar (según serie). **RAL 5010**
Couleurs standard (selon série). **RAL 7016**



Para otros colores hay un coste adicional.
Pour d'autres couleurs il y a un coût additionnel.
For others colours there is an additional cost.

	L x A x H	A ₂
104 0	654x645x1800	270
104 0 P	654x645x1880	270
104 0 R	654x645x1900	270
104 1	654x645x1800	270
104 1 P	654x645x1880	270
104 2 P	654x645x1900	270



Kit electricidad (toma 220V + ventilador + datos + magnetotérmico). Incluido.
Kit électricité (prise 220V + ventilateur + données + magnéto thermique). Inclus.
Power kit (220V plug + fan + data point + thermal magneto). Included.



Equipo informático no incluido.
Équipement informatique non inclus.
Computer equipment not included.

e 1 mm estructura chassis / frame

e 0,6 mm puertas portes / doors

SERIE 104 STANDARD

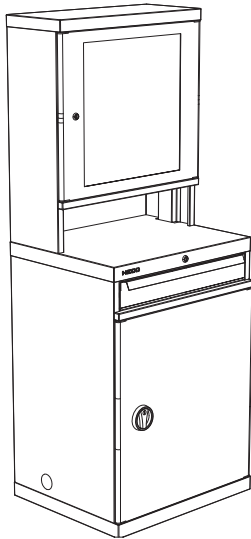

		L x A x H
104 0	40 Kg	654 x 645 x 1800

* Zócalo Base / Base board



Kit electricidad incluido.
Kit électricité inclus.
Included power kit.

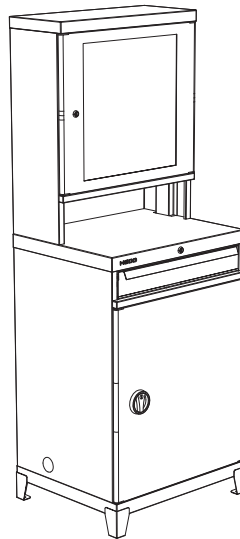

		L x A x H
104 0 P	41 Kg	654 x 645 x 1880

*Patas Pieds / Stands



Kit electricidad incluido.
Kit électricité inclus.
Included power kit.

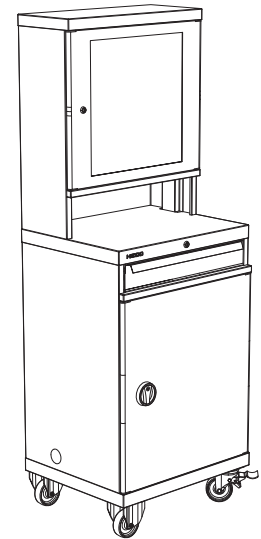

		L x A x H
104 0 R	42 Kg	654 x 645 x 1900

*Ruedas Roues / Wheels



Kit electricidad incluido.
Kit électricité inclus.
Included power kit.

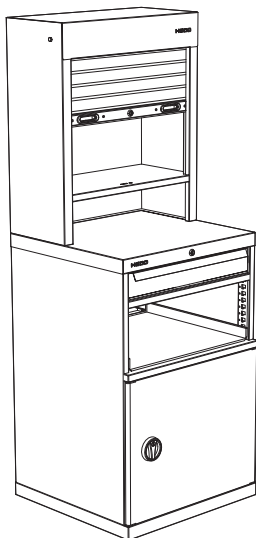

		L x A x H
104 1	41 Kg	654 x 645 x 1800

* Zócalo Base / Base board



Kit electricidad incluido.
Kit électricité inclus.
Included power kit.

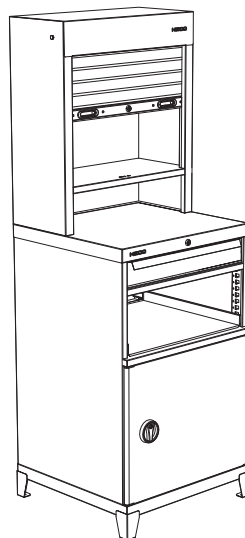

		L x A x H
104 1 P	42 Kg	654 x 645 x 1880

*Patas Pieds / Stands



Kit electricidad incluido.
Kit électricité inclus.
Included power kit.

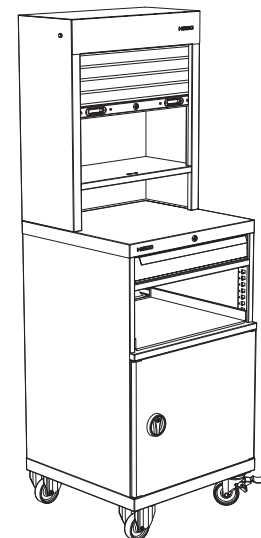

		L x A x H
104 1 R	43 Kg	654 x 645 x 1900

*Ruedas Roues / Wheels



Kit electricidad incluido.
Kit électricité inclus.
Included power kit.

SERIE 104 0 1

Armario PC opción con persiana.
Armoire PC option avec rideau.
PC cabinet with shutter closure.



104 0 1

RUEDAS ROUES WHEELS

Ø 100 mm

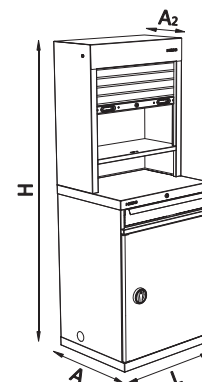

	L x A x H	A ₂
104 0 1	654x645x1800	270
104 0 1 P	654x645x1880	270
104 0 1 R	654x645x1900	270

e 1 mm estructura chasis / frame

e 0,6 mm puertas portes / doors

COLORES COULEURS COLOURS

Colores estándar (según serie).
Couleurs standard (selon série).
Standard colours (according to series).

RAL 5010
RAL 7016



Equipo informático no incluido.
Équipement informatique non inclus.
Computer equipment not included.



Kit electricidad (toma 220V + ventilador + datos + magnetotérmico). Incluido.
Kit électricité (prise 220V + ventilateur + données + magnéto thermique). Inclus.
Power kit (220V plug + fan + data point + thermal magnet). Included.

SERIE 104 STANDARD

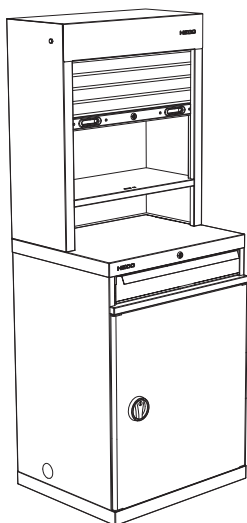

		L x A x H
104 0 1	43 Kg	654 x 645 x 1800

* Zócalo Base / Base board



Kit electricidad incluido.
Kit électricité inclus.
Included power kit.

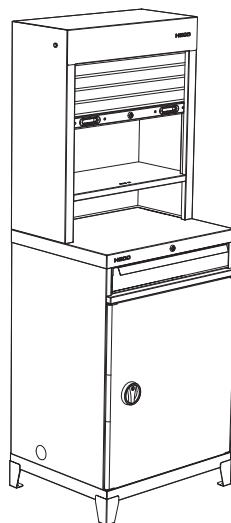

		L x A x H
104 0 1 P	44 Kg	654 x 645 x 1880

* Patas Pieds / Stands



Kit electricidad incluido.
Kit électricité inclus.
Included power kit.

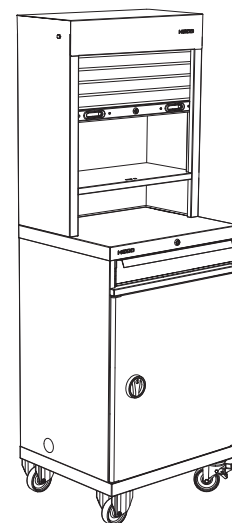

		L x A x H
104 0 1 R	45 Kg	654 x 645 x 1900

* Ruedas Roues / Wheels



Kit electricidad incluido.
Kit électricité inclus.
Included power kit.

SERIE 104 1 0

Armario PC opción con puerta de metacrilato y bandeja extraíble.
Armoire PC option avec porte de méthacrylate et plateau amovible.
PC cabinet with methacrylate door and removable tray.



104 1 0

RUEDAS ROUES WHEELS

Ø 100 mm

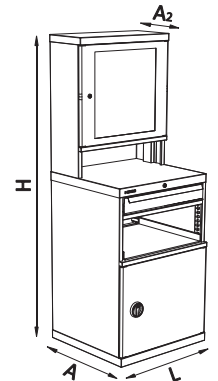

	L x A x H	A ₂
104 1 0	654x645x1800	270
104 1 0 P	654x645x1880	270
104 1 0 R	654x645x1900	270

e 1 mm estructura chasis / frame

e 0,6 mm puertas portes / doors

COLORES COULEURS COLOURS

Colores estándar (según serie).
Couleurs standard (selon série).
Standard colours (according to series).

RAL 5010
RAL 7016



Equipo informático no incluido.
Équipement informatique non inclus.
Computer equipment not included.



Kit electricidad (toma 220V + ventilador + datos + magnetotérmico). Incluido.
Kit électricité (prise 220V + ventilateur + données + magnéto thermique). Inclus.
Power kit (220V plug + fan + data point + thermal magneto). Included.

SERIE 104 STANDARD

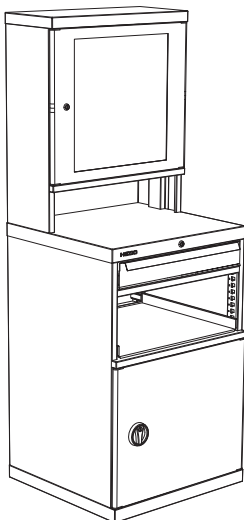

		L x A x H
104 1 0	38 Kg	654 x 645 x 1800

*Zócalo Base / Base board



Kit electricidad incluido.
Kit électricité inclus.
Included power kit.

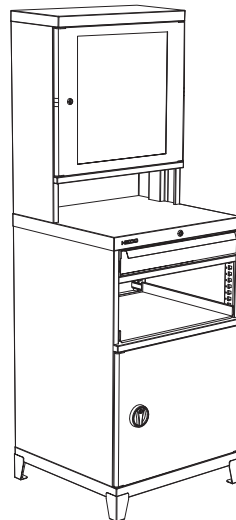

		L x A x H
104 1 0 P	39 Kg	654 x 645 x 1880

*Patas Pieds / Stands



Kit electricidad incluido.
Kit électricité inclus.
Included power kit.

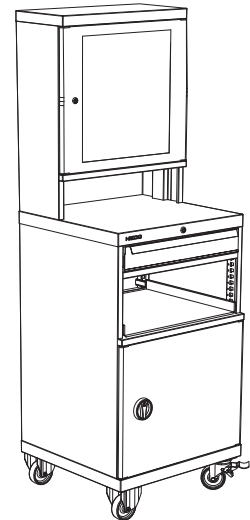

		L x A x H
104 1 0 R	40 Kg	654 x 645 x 1900

*Ruedas Roues / Wheels



Kit electricidad incluido.
Kit électricité inclus.
Included power kit.