

ARMARIOS PC



ES

- Armario modular para PC.
- Para pantallas planas de hasta 23".
- Configure su armario según sus necesidades.
- Disponible con o sin ruedas.
- Disponible conexiones eléctricas y de datos.
- Colores en opción.
- Material informático no se suministra.





Armario PC opción con puerta o persiana.
 Armoire PC option avec porte ou rideau.
 PC cabinet with door or shutter closure.

103 1

103 1 P

103 1/2/3/4

Puerta de metacrilato y configuración estándar.
 Porte en méthacrylate et configuration standard.
 Methacrylate door and standard configuration.

104 1 P/103 2 P

Persiana y configuración estándar.
 Rideau et configuration standard.
 Shutter closure and standard configuration.

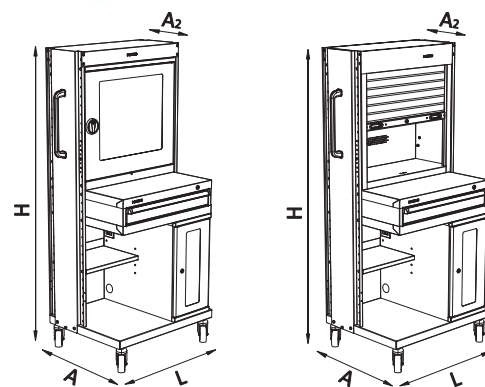
RUEDAS ROUES WHEELS

Ø 100 mm

COLORES COULEURS COLOURS

Colores estándar (según serie).
 Couleurs standard (selon série).
 Standard colours (as shown above).

RAL 5010
RAL 7016

Para otros colores hay un coste adicional.
 Pour d'autres couleurs il y a un coût additionnel.
 For other colors, there is an additional cost.

	L x A x H	A ₂
103 1	895x630x1735	302
103 2	895x630x1735	302
103 3	895x630x1735	302
103 4	895x630x1735	302
103 1 R	895x630x1735	302
103 2 R	895x630x1735	302



Kit electricidad (toma 220V + ventiliador + datos + magnetotérmico). Según opción.
 Kit électricité (prise 220V + ventilateur + données + magnéto thermique). Selon option.
 Power kit (220V plug + fan + data point + thermal magneto). According to option.

e 1,5 mm laterales latéraux / laterals

Equipo informático no incluido.
 Equipement informatique non inclus.
 Computer equipment not included.

e 1 mm estructura chassis / frame

e 0,6 mm puertas portes / doors

SERIE 103 STANDARD

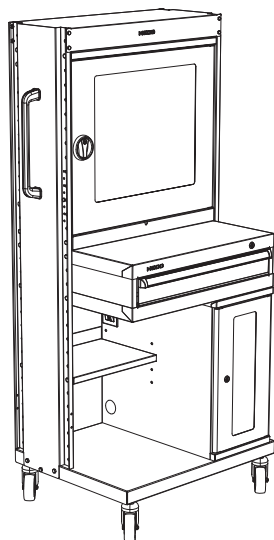

L x A x H		
103 1	75 Kg	895 x 630 x 1735

componentes / composants / composants	
103	estructura / châssis / frame
103 001	armario pantalla/ armoire écran / screen cabinet
103 002	cajón / tiroir / drawer
103 003 PV	armario CPU/ armoire CPU / CPU cabinet
103 006	bandeja regulable / plateau réglable / adjustable shelf
103 008	4 ruedas / 4 roues / 4 wheels
149 004	2 asas / 2 poignées / 2 handles



Kit electricidad incluido.
Kit électricité inclus.
Included power kit.

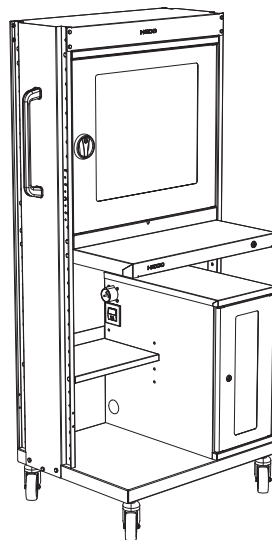

L x A x H		
103 2	55 Kg	895 x 630 x 1735

componentes / composants / composants	
103	estructura / châssis / frame
103 001	armario pantalla/ armoire écran / screen cabinet
103 003	armario CPU/ armoire CPU / CPU cabinet
103 004	plano de trabajo/ plan de travail / worktop
103 006	bandeja regulable / plateau réglable / adjustable shelf
103 008	4 ruedas / 4 roues / 4 wheels
149 004	2 asas / 2 poignées / 2 handles

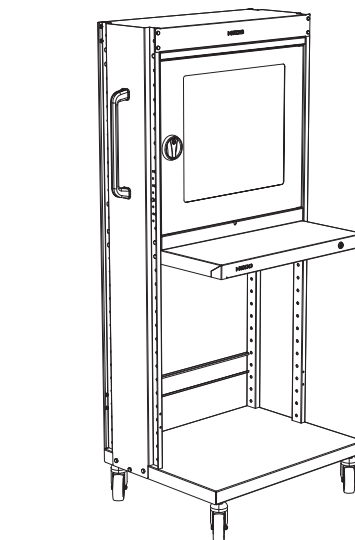

L x A x H		
103 3	45 Kg	895 x 630 x 1735

componentes / composants / composants	
103	estructura / châssis / frame
103 001	armario pantalla/ armoire écran / screen cabinet
103 004	plano de trabajo/ plan de travail / worktop
103 007	refuerzo / renfort / reinforcement
103 008	4 ruedas / 4 roues / 4 wheels
149 004	2 asas / 2 poignées / 2 handles

Kit electricidad incluido.
Kit électricité inclus.
Included power kit.

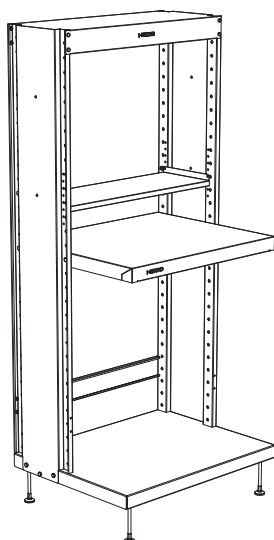

L x A x H		
103 4	33 Kg	895 x 630 x 1735

componentes / composants / composants	
103	estructura / châssis / frame
103 004	plano de trabajo/ plan de travail / worktop
103 005	bandeja regulable/ plateau réglable / adjustable shelf
103 007	refuerzo / renfort / reinforcement
103 009	4 patas regulables / 4 pieds réglables / 4 adjustable legs

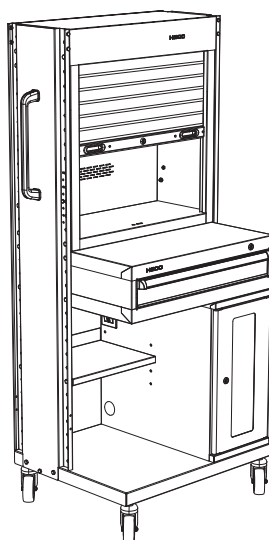

L x A x H		
103 1 P	60 Kg	895 x 630 x 1735



Kit electricidad incluido.
Kit électricité inclus.
Included power kit.

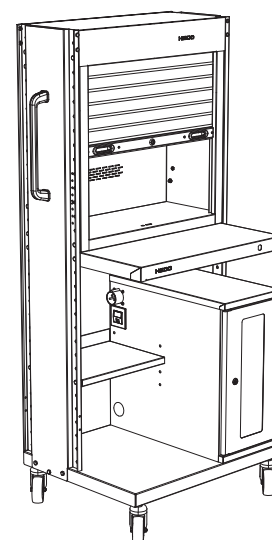

L x A x H		
103 2 P	60 Kg	895 x 630 x 1735



Kit electricidad incluido.
Kit électricité inclus.
Included power kit.